

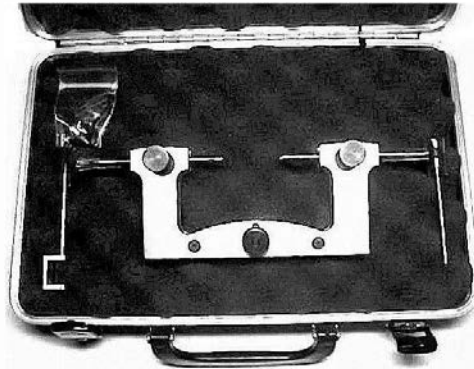

Clock Supplies

Keystone Tools

625 POPPY WAY
BROOMFIELD, CO. 80020
(303) 469-1220 : FAX: (303) 439-0186
email: parts@milehclocksupplies.com
[http:// www.milehclocksupplies.com](http://www.milehclocksupplies.com)

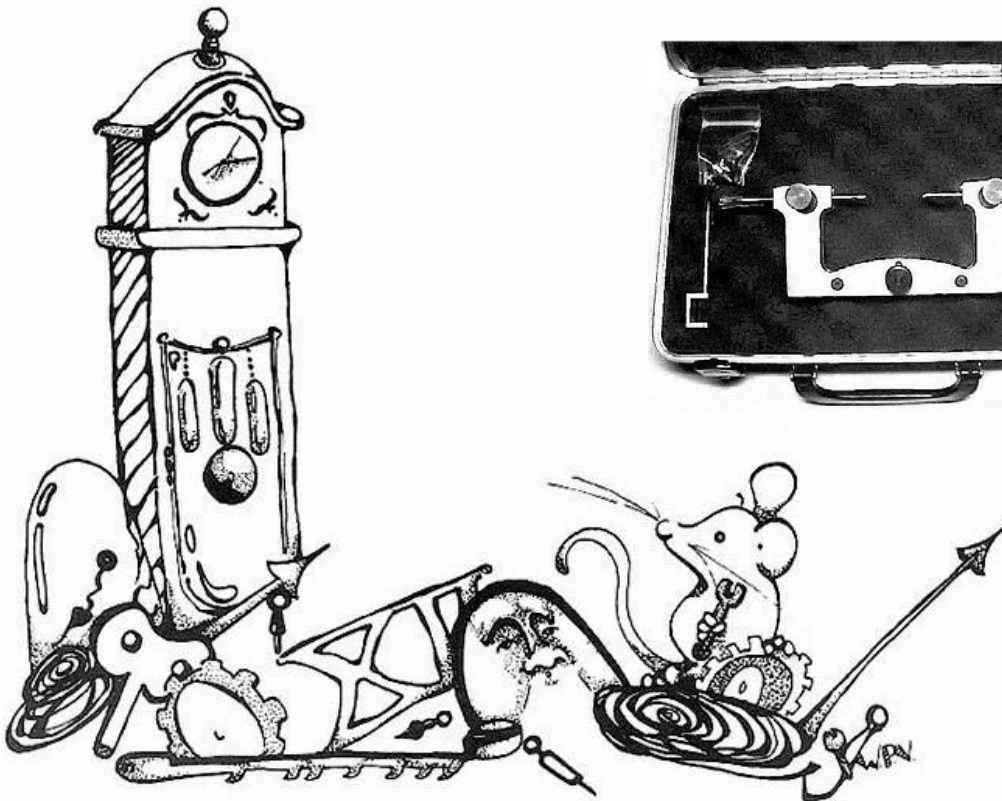
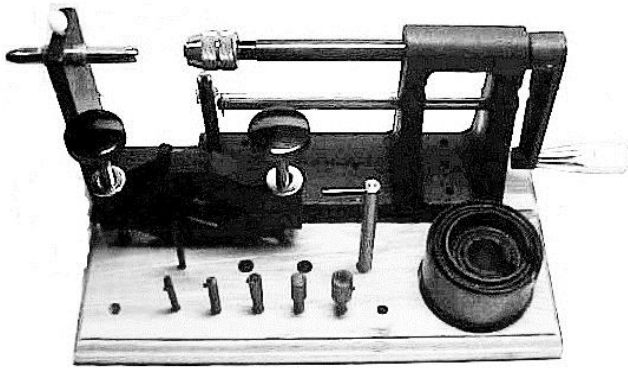

Mile Hi Clock Supplies / Keystone Tools

625 Poppy Way

Broomfield, CO 80020

Phone: 303 469-1220 Fax: 303 439-0186

E-mail: parts@milehicklocksupsupplies.com

Web Address: www.milehicklocksupsupplies.com

Mile Hi Clock Supplies is located in the heart of the Rocky Mountain Region, just North of Denver, Colorado. It is our goal to serve the Clock Industry with the highest quality merchandise that is available. All merchandise we sell is Guaranteed to your satisfaction.

ORDERS:

We have no minimum purchase orders, but orders less than \$ 15.00 will have a \$ 3.50 handling charge in addition to regular shipping charges. Orders will be shipped U.S. Postal Service or United Parcel Service (U.P.S.) all F.O.B. Broomfield, CO. On U.P.S. orders we need to have a complete street address – not just P.O. Box. All orders are billed At current prices. **PRICES ARE SUBJECT TO CHANGE WITHOUT NOTICE:**

PAYMENT:

We accept checks, money orders, Visa, Master Card and Discover First –Time orders must be Pre-Paid unless other Arrangements are made. Established accounts are given 30 days to pay. No notice is sent at the end of 30 days. You Pay from Invoice.

RETURNS:

Returns must be within 15 days of purchase. Enclose a copy of the invoice along with an explanation for the reason of returning. Special order items are returnable. Returned merchandise will be charged \$ 5.00. Returned merchandise must be in **NEW AND UNDAMAGED CONDITION,** and not **ALTERED** in any way.

PRICING:

All prices in this Catalog are effective as of 7/1/2016. All orders will be Invoiced at current market prices. If you have any question on what market price of a item please call for price. **303-469-1220** Descriptions of merchandise are also subject to change without notice.

TOLL FREE NUMBER FOR ORDERS:

Phone: 1-877-906-1220

Fax: 1-877-909-1220

FOR INFORMATION & TECHNICAL ASSISTANCE:

Phone: 1-303-469-1220

We are not responsible for any damage or injury incurred from The merchandise we sell. We are not responsible for typographical errors or omissions.

**We stock many items not included in our Catalog
Please inquire if you are looking for something special.**

Thank You for your business.

We accept these Credit Cards as Payment



Prices Effective 7/1/2016

**The 2016 catalog is dedicated in the
memory of my loving wife of 54 years,
Margene Oswald.**

COMPARISON OF MEASUREMENTS

Inch	M/M	B. & S. Gauge	Stubbs Steel Wire	Drill No.	Inch	M/M	B. & S. Gauge	Stubbs Steel Wire	Drill No.	Inch	M/M	B. & S. Gauge	Stubbs Steel Wire	Drill No.
.0130	0.330	—	80	—	.0630	1.600	—	52	—	.1440	3.662	—	—	27
.0135	0.343	—	—	80	.0635	1.613	—	—	52	.1443	3.670	7	—	—
.0140	0.356	—	79	—	.0641	1.629	14	—	—	.1460	3.712	—	26	—
.0142	0.361	27	—	—	.0660	1.676	—	51	—	.1470	3.758	—	—	26
.0145	0.369	—	—	79	.0670	1.702	—	—	51	.1480	3.763	—	25	—
.0150	0.381	—	78	—	.0690	1.753	—	50	—	.1495	3.802	—	—	25
.0159	0.404	26	—	—	.0700	1.778	—	—	50	.1510	3.835	—	24	—
.0160	0.406	—	77	78	.0720	1.829	13	49	—	.1520	3.861	—	—	24
.0179	0.455	25	—	—	.0730	1.854	—	—	49	.1530	3.886	—	23	—
.0180	0.457	—	76	77	.0750	1.905	—	48	—	.1540	3.912	—	—	23
.0200	0.508	—	75	76	.0760	1.930	—	—	48	.1550	3.937	—	22	—
.0201	0.511	24	—	—	.0770	1.956	—	47	—	.1510	3.988	—	21	22
.0210	0.533	—	—	75	.0785	1.994	—	—	47	.1590	4.039	—	—	21
.0220	0.559	—	74	—	.0790	2.007	—	46	—	.1610	4.085	—	20	20
.0225	0.572	—	—	74	.0808	2.052	12	—	—	.1620	4.111	6	—	—
.0226	0.574	23	—	—	.0810	2.057	—	45	46	.1640	4.162	—	19	—
.0230	0.584	—	73	—	.0820	2.083	—	—	45	.1660	4.212	—	—	19
.0240	0.610	—	72	73	.0850	2.159	—	44	—	.1680	4.263	—	18	—
.0250	0.635	—	—	72	.0860	2.184	—	—	44	.1695	4.302	—	—	18
.0253	0.643	22	—	—	.0880	2.235	—	43	—	.1720	4.371	—	17	—
.0260	0.660	—	71	71	.0890	2.261	—	—	43	.1730	4.396	—	—	17
.0270	0.685	—	70	—	.0907	2.304	11	—	—	.1750	4.447	—	16	—
.0280	0.712	—	—	70	.0920	2.337	—	42	—	.1770	4.498	—	—	16
.0285	0.724	21	—	—	.0935	2.378	—	—	42	.1780	4.523	—	15	—
.0290	0.737	—	69	—	.0950	2.413	—	41	—	.1800	4.570	—	14	15
.02925	0.743	—	—	69	.0960	2.438	—	—	41	.1819	4.618	5	—	—
.0300	0.762	—	68	—	.0970	2.464	—	40	—	.1820	4.621	—	13	14
.0310	0.787	—	67	68	.0980	2.489	—	—	40	.1850	4.697	—	12	13
.0320	0.813	20	66	67	.0990	2.515	—	39	—	.1880	4.773	—	11	—
.0330	0.838	—	65	66	.0995	2.528	—	—	39	.1890	4.799	—	—	12
.0350	0.889	—	64	65	.1010	2.565	—	38	—	.1910	4.855	—	10	11
.0359	0.912	19	—	—	.1015	2.578	—	—	38	.1935	4.919	—	—	10
.0360	0.914	—	63	64	.1019	2.588	10	—	—	.1940	4.932	—	9	—
.0370	0.940	—	62	63	.1030	2.616	—	37	—	.1960	4.982	—	—	9
.0380	0.965	—	61	62	.1040	2.642	—	—	37	.1970	5.008	—	8	—
.0390	0.990	—	60	61	.1060	2.692	—	36	—	.1990	5.059	—	7	8
.0400	1.016	—	59	60	.1065	2.705	—	—	36	.2010	5.105	—	6	7
.0403	1.024	18	—	—	.1080	2.743	—	35	—	.2040	5.182	—	5	6
.0410	1.041	—	58	59	.1100	2.794	—	34	35	.2043	5.189	4	—	—
.0420	1.067	—	57	58	.1110	2.819	—	—	34	.2055	5.220	—	—	5
.0430	1.092	—	—	57	.1120	2.845	—	33	—	.2070	5.258	—	4	—
.0450	1.143	—	56	—	.1130	2.870	—	—	33	.2090	5.309	—	—	4
.0453	1.151	17	—	—	.1144	2.906	9	—	—	.2120	5.381	—	3	—
.0465	1.181	—	—	56	.1150	2.921	—	32	—	.2130	5.406	—	—	3
.0500	1.270	—	55	—	.1160	2.946	—	—	32	.2190	5.559	—	2	—
.0508	1.290	16	—	—	.1200	3.048	—	31	31	.2210	5.615	—	—	2
.0520	1.321	—	—	55	.1270	3.226	—	30	—	.2270	5.768	—	1	—
.0550	1.397	—	54	54	.1285	3.264	8	—	30	.2280	5.793	—	—	1
.0571	1.450	15	—	—	.1340	3.404	—	29	—	.2294	5.829	3	—	—
.0580	1.473	—	53	—	.1360	3.454	—	—	29	.2576	6.543	2	—	—
.0595	1.512	—	—	53	.1390	3.531	—	28	—	.2893	7.346	1	—	—
					.1405	3.573	—	—	28					
					.1430	3.636	—	27	—					



American Made SINGLE END

	<u>Hole Size</u>	<u>Each</u>	<u>12 pc</u>
CK-00	2.20 mm	\$ 2.50	\$ 2.25 ea.
CK-0	2.40 mm	\$ 2.50	\$ 2.25 ea.
CK-1	2.60 mm	\$ 2.50	\$ 2.25 ea.
CK-2	2.80 mm	\$ 2.50	\$ 2.25 ea.
CK-3	3.00 mm	\$ 2.50	\$ 2.25 ea.
CK-4	3.20 mm	\$ 2.50	\$ 2.25 ea.
CK-5	3.40 mm	\$ 2.50	\$ 2.25 ea.
CK-6	3.60 mm	\$ 2.50	\$ 2.25 ea.
CK-7	3.80 mm	\$ 2.50	\$ 2.25 ea.
CK-8	4.00 mm	\$ 2.50	\$ 2.25 ea.
CK-9	4.20 mm	\$ 2.50	\$ 2.25 ea.
CK-10	4.40 mm	\$ 2.50	\$ 2.25 ea.
CK-11	4.60 mm	\$ 2.50	\$ 2.25 ea.
CK-12	4.80 mm	\$ 2.50	\$ 2.25 ea.
50 pc.		\$ 2.15 ea.	\$ 107.50



American Made SINGLE END LONG SHAFT

	<u>Hole Size</u>	<u>Each</u>	<u>12 pc.</u>
CKL-3	3.00 mm	\$ 2.50	\$ 2.25 ea.
CKL-4	3.20 mm	\$ 2.50	\$ 2.25 ea.
CKL-6	3.60 mm	\$ 2.50	\$ 2.25 ea.
CKL-8	4.00 mm	\$ 2.50	\$ 2.25 ea.
CKL-11	4.60 mm	\$ 2.50	\$ 2.25 ea.



American Made DOUBLE END

	<u>Hole Size</u>	<u>Each</u>	<u>12 pc</u>
CKD-4/1	3.2/2.4 mm	\$ 2.75	\$ 2.50ea.
CKD-4/3	3.2/2.0 mm	\$ 2.75	\$ 2.50ea.
CKD-4/5	3.2/1.6 mm	\$ 2.75	\$ 2.50ea.
CKD-5/1	3.4/2.4 mm	\$ 2.75	\$ 2.50ea.
CKD-5/3	3.4/2.0 mm	\$ 2.75	\$ 2.50ea.
CKD-5/5	3.4/1.6 mm	\$ 2.75	\$ 2.50ea.
CKD-6/1	3.6/2.4 mm	\$ 2.75	\$ 2.50ea.
CKD-6/3	3.6/2.0 mm	\$ 2.75	\$ 2.50ea.
CKD-6/4	3.6/1.8 mm	\$ 2.75	\$ 2.50ea.
CKD-6/5	3.6/1.6 mm	\$ 2.75	\$ 2.50ea.
CKD-7/1	3.8/2.4 mm	\$ 2.75	\$ 2.50ea.
CKD-7/3	3.8/2.0 mm	\$ 2.75	\$ 2.50ea.
CKD-7/5	3.8/1.6 mm	\$ 2.75	\$ 2.50ea.
CKD-8/1	4.0/2.4 mm	\$ 2.75	\$ 2.50ea.
CKD-8/3	4.0/2.0 mm	\$ 2.75	\$ 2.50ea.
CKD-8/5	4.0/1.6 mm	\$ 2.75	\$ 2.50ea.
50 pc		\$ 2.35 ea.	\$ 117.50

KEYS

Brass Double End Key Kit American Made

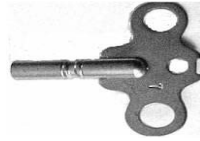

74.324	# 4	3.2 mm Large End
74.325	# 5	3.4 mm Large End
74.326	# 6	3.6 mm Large End
74.327	# 7	3.8 mm Large End
74.328	# 8	4.0 mm Large End
\$ 1.75 ea.		6 or more \$ 1.50 ea.

Brass Double End Key Kit Small End American Made



74.318	# 1	2.6 mm Small End
74.319	# 1/0	2.4 mm Small End
74.320	# 2/0	2.2 mm Small End
74.321	# 3/0	2.0 mm Small End
74.322	# 4/0	1.8 mm Small End
74.323	# 5/0	1.6 mm Small End
\$ 0.75 ea.		12 or more \$ 0.50 ea.

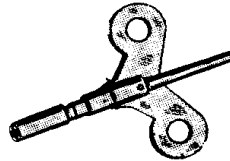

American Made DOUBLE END LONG SHAFT

	<u>Hole Size</u>	<u>Each</u>	<u>For 3</u>
CKDL-4/4	3.2/1.8 mm	\$ 4.25	..\$ 4.00ea
CKDL-6/4	3.6/1.8 mm	\$ 4.25	..\$ 4.00ea
CKDL-8/1	4.0/2.4 mm	\$ 4.25	..\$ 4.00ea
CKDL-6/4ST	Trademark Seth Thomas		
CKDL-6/4ST	3.6/1.8 mm	\$ 4.25	..\$ 4.00ea
CKDL-9/4	4.2/2.0 mm	\$ 5.25	..\$ 5.00ea
CKDL-13/4	5.0/1.8 mm	\$ 5.25	..\$ 5.00ea



WIDE WING SINGLE END American Made

<u>No.</u>	<u>Key Size</u>	<u>Hole Size (mm)</u>
74.206	6	3.60
74.207	7	3.80
74.208	8	4.00
74.210	10	4.40
74.212	12	4.80
74.213	13	5.00
74.214	14	5.75
74.216	16	5.60
\$ 3.50 ea.	\$ 39.00 per doz.

FRENCH KEY



	<u>Key Size</u>	<u>Hole Size</u>	<u>Price</u>
India Made			
74.358	1	2.50 mm	.. \$ 4.00 ea.
74.359	2	2.75 mm	.. \$ 4.00 ea.
74.360	3	3.00 mm	.. \$ 4.00 ea.
74.361	4	3.25 mm	.. \$ 4.00 ea.
74.362	5	3.50 mm	.. \$ 4.00 ea.
74.363	6	3.75 mm	.. \$ 4.00 ea.
74.365	7	4.00 mm	.. \$ 4.00 ea.
74.367	8	4.25 mm	.. \$ 4.00 ea.
74.369	9	4.50 mm	.. \$ 4.00 ea.
74.370	10	4.75 mm	.. \$ 4.00 ea.
74.371	11	5.00 mm	.. \$ 4.00 ea.
74.376	16	6.25 mm	.. \$ 4.00 ea.

VIENNA CRANK KEYS



Brass key shank w/ wire crank American made

	<u>Key Size</u>	<u>Hole Size</u>	<u>Price</u>
74.558	3/0	2.00 mm	.. \$ 2.25 ea.
74.559	2/0	2.20 mm	.. \$ 2.25 ea.
74.560	0	2.40 mm	.. \$ 2.25 ea.
74.561	1	2.60 mm	.. \$ 2.25 ea.
74.562	2	2.80 mm	.. \$ 2.25 ea.
74.563	3	3.00 mm	.. \$ 2.25 ea.
74.564	4	3.20 mm	.. \$ 2.25 ea.
74.565	5	3.40 mm	.. \$ 2.25 ea.
74.566	6	3.60 mm	.. \$ 2.25 ea.
74.567	7	3.80 mm	.. \$ 2.25 ea.
74.568	8	4.00 mm	.. \$ 2.25 ea.
		12 and up	\$ 2.00 ea.

Old Style Letdown Key



Wood handle letdown key. Can be used to wind a mainspring or to let it down. The wood handle is of hard wood and the metal is of brass.

24.616	Size 5-6 \$ 11.50 ea.
24.617	Size 7-8 \$ 11.50 ea.
24.618	Size 10-12 \$ 11.50 ea.
	3 or More	\$ 11.25 each

Swiss Key Gauge for Clocks



71.231 \$ 12.50 ea.
Prices Subject To Change Without Notice.

**NOVELTY KEYS
American Made**



Key Size	Hole Size	Price
74.339	2/0 2.20 mm	\$ 2.00 ea.
74.340	1/0 2.40 mm	\$ 2.00 ea.
74.341	1 2.60 mm	\$ 2.00 ea.
74.342	2 2.80 mm	\$ 2.00 ea.
74.343	3 3.00 mm	\$ 2.00 ea.
74.344	4 3.20 mm	\$ 2.00 ea.
74.345	5 3.40 mm	\$ 2.00 ea.

Mix Or Match For Doz. Price \$ 21.00 Doz.

Pendulet Key

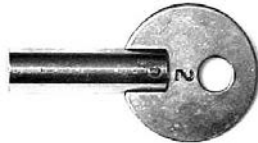

These keys are Nickel Plated. They are used on Keebler clocks and Lux clock and other small clocks.

74.260	2.6 mm	# 1
74.261	2.8 mm	# 2
74.262	3.0 mm	# 3
\$ 1.75 ea.	12 & up	\$ 1.50 ea.

Chelsea Keys



74.412	# 000	2.0 mm	\$ 3.25
74.413	# 3	3.0 mm	\$ 3.25
74.416	# 5	3.4 mm	\$ 3.25
	12 and up		\$ 3.25 ea.

400 Day Clock Key



American Made

74.250	SCHATZ, HALLER	-- 3.0 mm
74.251	KUNDO, KERN	- 3.6 mm
74.252	Kundo Small, Schatz, Haller Standard	- 4.0 mm ... # 8
74.253	Kundo Large	- 4.6 mm .. # 11
\$ 2.50 ea.	3 or more	\$ 2.25 ea.
	12 or more	\$ 2.00 ea.

**Schatz long Key Shaft 2-5/16
American Made**



74.249	Schatz Long Shaft	3.0 mm
\$ 3.50 ea.	3 or more	\$ 3.25 ea.

Prices Subject To Change Without Notice.



ECONOMY WATCH KEY

Key Size	Hole Size	Price
75.098	00 2.00 mm	\$ 1.50 ea.
75.099	0 1.90 mm	\$ 1.50 ea.
75.101	1 1.80 mm	\$ 1.50 ea.
75.102	2 1.75 mm	\$ 1.50 ea.
75.103	3 1.65 mm	\$ 1.50 ea.
75.104	4 1.60 mm	\$ 1.50 ea.
75.105	5 1.50 mm	\$ 1.50 ea.
75.106	6 1.40 mm	\$ 1.50 ea.
75.107	7 1.30 mm	\$ 1.50 ea.
75.108	8 1.20 mm	\$ 1.50 ea.
75.109	9 1.15 mm	\$ 1.50 ea.
75.110	10 1.05 mm	\$ 1.50 ea.
75.111	11 1.00 mm	\$ 1.50 ea.
75.112	12 0.95 mm	\$ 1.50 ea.

Mix or Match for Doz. Price.
\$ 16.75 Per Doz.

POCKET WATCH STAR KEYS



Star Keys for Pocket Watches sizes Even and Odd

24.626	.. Even Sizes 2,4,6,8,10	.. \$ 6.00 ea.
24.627	.. Odd Sizes 3,5,7,9,11	.. \$ 6.00 ea.

GRANDFATHER CLOCK CRANKS



American Made .. With Hardwood Handle

Key Size	Hole Size	Price
74.538	8 4.00 mm	\$ 15.00 ea.
74.539	9 4.20 mm	\$ 15.00 ea.
74.540	10 4.40 mm	\$ 15.00 ea.
74.541	11 4.60 mm	\$ 15.00 ea.
74.542	12 4.80 mm	\$ 15.00 ea.
74.543	13 5.00 mm	\$ 15.00 ea.
74.544	14 5.20 mm	\$ 15.00 ea.
74.545	15 5.40 mm	\$ 15.00 ea.
74.546	16 5.60 mm	\$ 15.00 ea.
74.548	18 6.00 mm	\$ 15.00 ea.
74.520	20 6.40 mm	\$ 15.00 ea.
74.522	22 6.80 mm	\$ 15.00 ea.
6 or more		\$ 14.75 ea.

Wood Stand For Letdown Key Set



Wood stand to keep your letdown Key set all together.

24.620 \$ 9.00 ea.
--------	-------------------

**STAR KEYS - BRASS 5 PRONG
American Made**

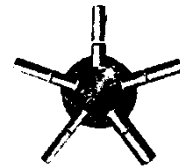

24.621	.. Mixed Sizes 0,1,2,13,14
24.622	.. Odd Sizes 3,5,7,9,11
24.623	.. Even Sizes 4,6,8,10,12
\$ 10.50 ea. 3 or more	\$ 10.25 ea.

**LET DOWN KEYS SET
SET OF 6 CHUCKS W/HANDLE
Sizes: 1-2, 3-4, 5-6, 7-8, 10-12, 14-16**



24.625 \$ 58.50 SET
--------	--------------------

Individual Chuck



24.630	.. #00-0 2.4/2.2 mm Chuck
24.631	.. # 1-2 2.6/2.8 mm Chuck
24.632	.. # 3-4 3.0/3.2 mm Chuck
24.633	.. # 5-6 3.4/3.6 mm Chuck
24.634	.. # 7-8 3.8/4.0 mm Chuck
24.635	.. # 9-11 4.2/4.6 mm Chuck
24.636	.. # 10-12 4.4/4.8 mm Chuck
24.637	.. # 14-16 5.2/5.6 mm Chuck
\$ 7.75 each 3 or more	\$ 7.50 each



ALARM CHUCK

24.638 \$ 10.00 each
--------	---------------------

Lever Adjust & Wire Bending



Has a Hex Center to fit either Let Down Handle. This tool can be used to form wire, Adjust levers and etc.

12.330 \$ 8.00 ea.
--------	-------------------

LET DOWN KEYS Handle



Let Down handle only (Plastic).

24.628 \$ 14.25
--------	----------------



Large Let-Down Handle (Plastic)

24.629 \$ 16.25
--------	----------------

Time Clock Key



American Made

Brass shaft with steel bar for T handle

- 74.550 # 20 6.4 mm
- 74.551 # 23 7.0 mm
- \$ 12.00 each 3 or more \$ 11.75 ea.

KEY SIZE CHART

key size	5/0	4/0	3/0	2/0	0	1	2
mm	1.6	1.8	2.0	2.2	2.4	2.6	2.8
key size	3	4	5	6	7	8	9
mm	3.0	3.2	3.4	3.6	3.8	4.0	4.2
key size	10	11	12	13	14	15	16
mm	4.4	4.6	4.8	5.0	5.2	5.4	5.6
key size	17	18	19	20	21	22	23
mm	5.8	6.0	6.2	6.4	6.6	6.8	7.0

S.T Cylindrical Pendulum



Metal rod with Brass hook with brass bob
On rod. Rod can be shortened if needed.
Overall length of pendulum 6*1/4" with a
5/8" brass bob.
76.126 \$ 9.75 ea.

Brass Leaf Pendulum



Hole end Brass leaf pendulum.
2-3/8" diameter bob with 6-3/4" rod.
76.219 \$ 11.75 ea.

Ansonia Pendulums



Ansonia pendulums square rod with
1-5/8" diameter bob. Brass covered.
76.216 Rod length 3-1/2"
76.217 Rod length 5-1/8"
76.218 Rod length 8-1/2"
\$14.50 ea. 3 or more \$ 14.25 ea.

Fancy Waterbury Pendulum Bob



Waterbury fancy antique gold finish.
1-3/8" diameter ... 2.4 oz.
76.234 \$ 6.25 ea.

PENDULUM BOBS



76.351 76.352 76.353
Gilbert Ingraham Ingraham
1-1/2 X 2.5 oz 1-1/2 x 2.4 oz 1-1/2 x 2.4 oz



76.350 76.354 76.358
Seth Thomas Seth Thomas Seth Thomas
Boy On Fence Adamantine Mantle
1-5/8 x 3.6 oz 1-3/4 x 5 oz 1-13/16 x 4 oz



76.310 76.313 76.312
Sessions Sessions Waterbury
1.5 oz 1-1/2 x 3 oz 2.2 oz



76.357 76.305
Universal Universal
Floral pattern Flat
1 1/2 x 2.2 oz 1 1/2 x 2.2 oz
\$ 4.00 ea 3 or more \$ 3.75 ea

Adjustable Pendulum Bob



Seth Thomas Adjustable Bob
1 3/4 x 5 oz
76.230 \$ 6.50 ea

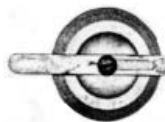

Solid Brass New Haven Adjustable Bob
1 3/8 dia Bob 1-3/4 oz weight.
76.359 \$ 7.50

Seth Thomas Pendulum



The rod is 3-7/8" long. Bob is 2-7/16 Dia.
76.135 \$ 14.50

FRENCH BOBS



3-48 Thread rod Use Hook #76.390
76.119 ... 1 1/4" dia. 2oz. \$13.00 ea.
76.120 ... 1 3/8" dia. 2-1/2oz ... \$14.25 ea.
76.125 ... 1 1/2" dia. 3 oz. \$15.25 ea.



76.390 76.391 76.392
76.390 3-48 Thread ... \$ 2.00 ea.
76.391 No Thread \$ 2.00 ea.
76.392 4-40 Thread ... \$ 2.50 ea.



**UNIVERSAL ADJUSTABLE
PENDULUM BOB**

Threaded rod can be shortened for variety
of Clock.Has adjustable 35 mm bob.
Weight 2 oz. Rod is 6 5/8" long.
76.115 \$ 12.00 ea.

Silk Thread Pendulum



This Silk Thread Pendulum is 11-3/8" long
with a 1-1/4" bob. The rod can be
shortened if needed.
76.116 \$ 8.25 ea.

Zaandam Pendulum



This Zaandam Pendulum is cast brass bob.
1-1/2" wide X 8-1/2" long . Adjustable
rod with hook on top.
76.112 \$ 10.50

Lead Adjustable Pendulum Bob



76.231 76.232 76.233
76.231 ... 2.4 oz ...1-5/8" dia. .. \$ 6.25 ea.
76.232 ... 1.5 oz .. 1-1/4" dia. .. \$ 5.75 ea.
76.233 ... 2.2 oz. . 1-1/8" dia. ... \$ 5.50 ea.



**BRASS COVERED BOBS
ADJUSTABLE**

76.215 ...11/2 " dia. X 2.0 oz ... \$ 6.25 ea
76.275...1 3/4" dia. X 2.3 oz ... \$ 6.50 ea
76.220... 2 " dia. X 3.1 oz... \$ 7.00 ea

Prices Subject To Change Without Notice.

**KITCHEN CLOCK PENDULUMS
COMPLETE WITH 6 1/4" ROD**



76.105 76.100 76.130 76.110
Antique Gold Finish
\$ 8.00 ea. ... 3 or more \$ 7.75

**OVAL PENDULUM RODS
WITH BRASS RATING NUT**



76.400 4-7/8" Long \$ 4.00 ea.
76.401 6 1/4" Long \$ 4.00 ea.
76.402 7 1/2" Long \$ 4.00 ea.
3 or more \$ 3.75 ea.

Tall Case Pendulum Complete



This pendulum has a 33" steel rod with 6/32 Thread on both ends, Brass rating assembly Suspension spring and 4-1/2" cast bob 2-1/2 lb.

76.653 \$ 35.00

English Bell Strike Bobs

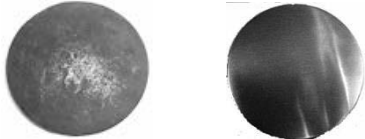

76.651 76.661

Cast Iron bob for tall case clocks. 3/8" slot 4-1/2" diameter bob 2-1/2 lbs.

76.651 \$ 20.00

Brass Covered Cast Iron bob for tall case clocks. 3/8" slot 4-1/2" diameter bob 2-1/2 lbs.

76.661 \$ 31.50

Steel Pendulum rod for Tall Case Clock



Steel rod threaded on both ends. 33" long
76.652 ... 6-32 thread.... \$ 4.75

Tall Case Rating Assembly



Brass Rating assembly for Tall Case clocks.
Made of Brass measures 6-1/2" long.
76.650 ... 6-32 thread... \$ 10.50

Seth Thomas # 2 Bob

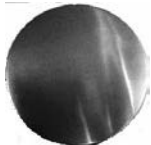

Brass Cover 4-1/2" Diam. ... 2 lb 8oz.
76.654 \$ 34.00 ea.
Prices Subject To Change Without Notice.

S.T. # 2 Pendulum Rod



Wood pendulum Rod 24.-1/2" long
Comes with Top Hook, Ware Plate and
Bottom Rating assembly all attached.
Wood is stained dark brown.

76.656 \$ 20.50

**Seth Thomas # 2 Pendulum
Complete with Rod & Bob**

76.657 \$ 45.00

Ansonia Bob

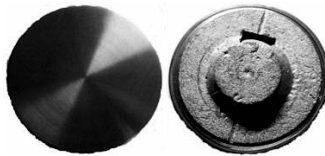

Brass covered over lead bob. 3-5/16"
Diameter with 5/8" slot. 9 oz weight
76.659 \$ 18.50

Ansonia Wood Stick



Wood Rod with hook & rating assembly
11-3/4" long X 5/8" wide. Stained wood.
76.658 \$ 10.50

Ansonia Pendulum Complete



Ansonia Pendulum Complete with rod & bob
76.660 \$ 28.00

Vienna Pendulum Bob



Brass covered . 5-3/4" diameter
for 3/4" wood rod.
76.655 \$ 22.00 ea.

SPUN BRASS DISC

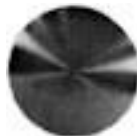

76.449 ... Polished Finished
4-1/2" Bob for 3/4" oval wood rod
76.449 \$ 14.00 ea.



Quartz Pendulum & Bob
15.215...Single hook 16" Rod 2-3/4" Bob
15.216 ..Single Hook 22" Rod 3-1/2 Bob
15.217 .. Bouble Hook 16" Rod 2-3/4' Bob
15.215 \$ 6.50, 15.216 \$ 8.75, 15.217 \$ 6.50

Novelty Pendulum Bobs



7-3/4" long . Rod 3/4" Bob is Brown.
76.207 ... Wood ... \$ 3.00 ea.

Miniature Novelty Pendulum



2-5/8 Long 5/8 bob
76.214 \$ 2.00 ea.

Universal German Style Pendulum Bob



Brass rod with split hook & brass bob.
76.239 ... 2-3/4 rod, 1-11/16 bob ... \$ 16.50
76.240 ... 3-1/16 rod, 1-11/16 bob ... \$ 16.75
76.241 ... 3-1/2 rod, 1-11/16 bob \$ 17.00
76.242 ... 4-1/2 rod, 1-11/16 bob \$ 17.50
76.243 ... 6" rod, 1-11/16 bob \$ 18.00

PENDULUM ACCESSORIES

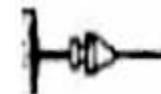

Rating Nut & Rod
76.1118
76.1119

76.1118 ... 3-1/2" Long \$ 2.50 ea.
76.1119 ... 4-3/4" Long \$ 3.50 ea.
3 or more of 76.1118 ... \$ 2.40 ea.
3 or more of 76.1119 ... \$ 3.25 ea.

WOOD PENDULUM HOOK



Urgos Hook Hermle Hook Jauch Hook
76.056 76.057 76.059
76.001

76.056... 3/4" wood Rod \$ 1.50 ea.
76.057... 3/4" wood Rod \$ 1.50 ea.
76.001... 1" wood Rod ... \$ 1.50 ea.
3 or more of a No. \$ 1.25 ea.
76.059 ... 3/4" wood Rod ... \$ 1.75 ea.
3 or More \$ 1.50 ea.

Pendulum Bob Wire



Steel wire with a brass rating nut.
76.381 2-5/8" long \$ 1.50 ea.

76.382 3-1/4" long \$ 1.50 ea.
76.383 4-1/4" long \$ 1.50 ea.
12 or more \$ 1.25 ea.

**OVAL WOOD PENDULUM ROD
Wood Rod are 36" Long**

76.475 ... 3/4" Oval Rod \$ 6.75 ea.
76.500 ... 1" Oval Rod \$ 7.00 ea.

Rating Assemblies



2-1/4" Long with a brass rating nut.
76.453 # 2 \$ 5.00 ea.



2-1/4" Long with a brass rating nut.
76.454 Vienna \$ 4.00 ea.



2-1/4" Long with a brass rating nut.
76.455 Regulator \$ 4.00 ea.



Rating Assembly 3 piece for ST # 2
Regulator. 3-1/8" overall length
Brass regulating nut with Steel straps
76.456 \$ 7.00 ea.



Rating Assembly 2 piece for ST # 2
Regulator. 2-3/8" overall length
76.457 \$ 5.50 ea.



Banjo Tie Down

Made of cast brass

2-1/8" long X 1/2" high.

76.481 \$ 8.75 ea.

Wear plates made of Brass helps the
Wearing of the pendulum rod on the wood.



76.451 1-7/6 long Vienna



76.452 2-3/8 long Regulator
\$1.50 ea.



Suspension bridge Brass finish. For
Tall Case clocks.

2-1/4" wide X 1-1/2" high X 1-1/2" Long
78.481 \$ 12.50

**Brass Pendulum Hook for # 2
Regulator.**



Pendulum hook for # 2 regulator for
3/4" wood rod.

76.058 \$ 4.00 ea.

VERGE PARTS



MADE OF BRASS

VERGE SADDLES 2 PER PKG.

CV79102 \$ 2.00 pkg.

SUSPENSION SPRING



3 PIECE SUSPENSION SPRING ON ROD

78.002002" Thick 18" Long

78.003003" Thick 18" Long

78.004004" Thick 18" Long

Mix Sizes OK. Sold in package of 12
\$ 6.75 doz.

2 or more doz. \$ 6.50 doz.

78.143004" Thick 13" Long

Sold in package of 12 ... \$ 5.25 Pkg.



Mantle Clock suspension Spring

2" feather004" thick ... 9" overall

Sold in packages of 12

78.142 \$ 9.50 doz.

**Ansonia swinger suspension spring
only Swinger Suspension Springs**



Set of 5 replacement swinger suspension
Springs. 4 are .0625 wide. 1 is .125 wide.

78.896004 thick \$ 4.75 set.

78.897007 thick \$ 4.75 set

S.T. # 2 SUSPENSION SPRING



1-3/16" long .0025" Thick

78.600 \$ 3.00 ea.

Hermle Balance



Hermle Balance for # 140, 150, 340,
350, 1050 Movements.

79.340 \$ 78.00 ea.

3 or more \$ 77.75 ea.

Pallet Fork for Hermle



Fork for # 140, 150, 340 Movements

79.341 \$ 10.25 ea.

3 or more \$ 10.00 ea.

HERSCHEDE SUSPENSION SPRING



78.630006" thick ... \$ 3.50

OLD ENGLISH SUSPENSION UNIT



With Brass Blocks on Top and Bottom

Bottom brass block is taped to # 6-32

78.475 ... 5-5/8" long ... \$ 6.50 ea.

ANSONIA SWINGER

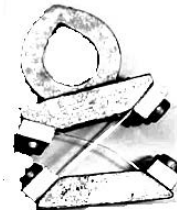

Replacement suspension unit for
Ansonia swinging arm clocks.

78.895 \$ 49.50 ea.

Suspension Springs

78.401 Part No.

4.5mm Overall Length
8.0mm Overall Width
10.50mm Hole To Pin
0.04mm Spring Thickness



16

78.416
20.0mm
8.0mm
12.5mm
0.05mm

\$9.50ea.
3 or
More
\$9.25ea.



48

78.448
23.25mm
14.0mm
15.5mm
0.06mm

\$9.00 ea.
3 or
More
\$8.75 ea.

Suspension Springs *Note

78.401 Part No.

14.5mm Overall Length
8.0mm Overall Width
10.50mm Hole To Pin
0.04mm Spring Thickness

Pendulum Length

for suspension Spring
78.503 ... 66 cm
78.504 ... 11cm-15 cm

 1 78.401 14.5mm 8.0mm 10.50mm 0.04mm	 2 78.402 15.5mm 8.0mm 11.50mm 0.04mm	 3 78.403 16.5mm 8.0mm 12.50mm 0.05mm	 4 78.404 17.5mm 8.0mm 13.50mm 0.05mm
 5 78.405 18.50mm 8.0mm 14.50mm 0.05mm	 6 78.406 19.5mm 8.0mm 15.5mm 0.06mm	 7 78.407 20.0mm 8.0mm 16.50mm 0.06mm	 8 78.408 18.0mm 8.0mm 13.5mm 0.04mm
 9 78.409 15.0mm 8.0mm 10.50mm 0.05mm	 10 78.410 17.0mm 8.0mm 12.5mm 0.05mm	 35 78.435 15.0mm 8.0mm 10.50mm 0.04mm	 36 78.436 17.5mm 8.0mm 12.5mm 0.05mm
 37 78.437 16.5mm 8.0mm 12.00mm 0.04mm	<p>\$ 3.25 ea. 3 To 11 \$ 3.00 ea 12 and Up \$ 2.75 ea.</p>		

 78.148 16.25mm 17.0mm 9.00mm 0.04mm	Kundo \$ 20.00 ea.	
<p>Urgos Suspension</p>		
78.610 43.5mm 11.5mm 32.0mm 0.10mm \$ 10.50 ea. 3 - \$ 10.25 ea.	78.619 28.5mm 8.25mm 19.0mm 0.05mm \$ 9.75 ea. 3- \$ 9.25 ea.	78.620 28.25mm 8.25mm 19.0mm 0.10mm \$ 9.75 ea. 3- \$ 9.25 ea.

 19 78.412 21.25mm 8.0mm 17.00mm 0.05mm	 13 78.413 24.0mm 8.0mm 19.0mm 0.05mm	 17 78.417 18.0mm 8.0mm 13.0mm 0.04mm	 19 78.419 15.5mm 10.0mm 10.5mm 0.06mm
 20 78.420 18.0mm 10.0mm 13.0mm 0.06mm	 21 78.421 21.0mm 10.0mm 16.0mm 0.06mm	 22 78.422 20.0mm 8.0mm 14.0mm 0.05mm Morbier	 23 78.423 19.25mm 8.0mm 12.50mm 0.05mm Morbier
 24 78.424 20.0mm 10.0mm 11.50mm 0.05mm Morbier	 25 78.425 23.75mm 10.0mm 17.0mm 0.05mm Morbier	 26 78.426 23.5mm 10.0mm 14.5mm 0.05mm Morbier	 33 78.438 17.5mm 8.0mm 12.5mm 0.05mm Becker
 38 78.439 21.5mm 8.0mm 17.0mm 0.05mm	<p>\$ 4.75 ea. 3 Or More \$ 4.50 ea. 12 and Up \$ 4.25 ea.</p>		

 40 78.440 32.75mm 14.0mm 26.0mm 0.07mm	 41 78.441 27.5mm 17.0mm 20.5mm 0.07mm	 42 78.442 25.0mm 14.0mm 20.50mm 0.07mm	 43 78.443 28.0mm 14.25mm 20.5mm 0.07mm
 45 78.445 25.0mm 12.0mm 18.0mm 0.06mm	 46 78.446 26.5mm 12.0mm 19.5mm 0.06mm	 47 78.447 23.5mm 12.0mm 18.00mm 0.06mm	<p>\$8.00ea 3 or More \$7.75ea</p>

 27 78.427 22.0mm 5.0mm 17.5mm 0.04mm French	 28 78.428 23.0mm 5.0mm 18.5mm 0.05mm French	 29 78.429 21.75mm 5.0mm 19.5mm 0.05mm French	 30 78.430 25.0mm 5.0mm 16.5mm 0.05mm French
 31 78.431 28.5mm 5.0mm 20.0mm 0.06mm French	 32 78.432 31.5mm 6.0mm 23.0mm 0.07mm French	 33 78.433 19.0mm 5.0mm 14.5mm 0.05mm	 49 78.449 24.0mm 10.0mm 19.5mm 0.06mm
<p>\$ 6.00 ea. 3 or More 5.75 ea.</p>			
 18 78.418 65.0mm 6.0mm 57.5mm 0.10mm \$ 7.00 ea. 3 or more \$ 6.75 ea.			

 * 78.503 17.5mm 8.0mm 12.0mm 0.04mm Hermle \$ 3.25 ea. 3 or More \$ 3.00 ea.	 * 78.504 17.5mm 8.0mm 12.0mm 0.04mm Hermle \$ 3.25 ea. 3 or More \$ 3.00 ea.	 78.505 17.25mm 8.0mm 12.5mm 0.05mm Hermle \$ 3.25 ea. 3 or More \$ 3.00 ea.
---	---	--

 78.534 25.25 mm 12.00 mm 15.5 mm 0.10 mm Kieninger \$ 7.75 ea 3 & up \$ 7.50	 78.535 24.00 mm 12.00 mm 15.0 mm 0.10 mm Kieninger \$ 9.25 ea 3 & up \$ 9.00	 78.356 17.5mm 8.0mm 12.0mm 0.08mm Kieninger \$ 3.25 ea. 3 & up \$ 3.00 ea.
---	---	---

Price Subject To Change With Out Notice.

PENDULUM ROD REPAIR KIT



Consists of 8 feathers and 8 clips
2 each of the springs listed below
78.301 \$ 7.75 pkg.

Suspension Spring Feathers



This suspension spring feather can be used on American clock and etc. The spring is 3/16" wide by 1-1/4" Long and comes in difference thickness. 12 pc to a package.

- 78.3020025 thick
 - 78.3030030 thick
 - 78.3040035 thick
 - 78.3050040 thick
- \$ 2.50 pkg. or 3pkg for \$ 2.25 pkg.



Brass connector for suspension spring feather

Sold in packages of 12 pc.
78.306 \$ 8.75 pkg.

SUSPENSION STEEL



COMES IN SHEETS 6" long X 1 1/2" wide

- 78.602002" Thickness ... \$ 6.25 ea.
- 78.603003" Thickness ... \$ 4.25 ea.
- 78.604004" Thickness ... \$ 3.75 ea.
- 78.605005" Thickness ... \$ 3.50 ea.
- 78.606006" Thickness ... \$ 3.00 ea.

Verge Assortment



Between plate assortment. 6 difference ones.

CV 79.116 \$ 10.00 pkg.

VERGE SET



Assortment of 12 Popular verges 2 ea. of 6 different ones. Need final polishing.

CV79.112 \$ 33.50

Prices Subject to change without notice

Verge .. Actual Size



CV79.054 \$ 5.50 ea.

- Half Dead Beat Verge
- E.N. Welch Dbl. Dial
- Ingraham 8 Day Mantel T & S
- Ithaca Dbl. Dial Cal.. T & S

UNIVERSAL VERGE

Actual Size, Distant between pallet .720"



CV79.051 \$ 5.50 ea.

VERGE STYLE # 1

- Ansonia School clock, 34T
- E.N. Welch 30 Hr. shelf, T&S, 34T
- E.N. Welch 8 Day Shelf, 29T
- E.N. Welch Eclipse Cal, 34T
- E.N. Welch 8 Day Kitchen, 41T
- E.N. Welch School Clock, 32T
- Gilbert 8 Day Kitchen, 41T
- Gilbert 8 Day Shelf, 42T
- Ingraham 8 Day Shelf, 40T
- Ingraham 8 Day Kitchen, 27T
- Ingraham 30 Hr. Kitchen, 45T
- Ingraham School Clock, 27T
- Ithaca Calander, 36T
- Japanese School Clock, 32T
- New Haven 8 Day Kitchen, 37T
- Sessions Regulator, 34T
- Session School Clock, 32T
- Sessions 8 Day Shelf, 41T
- Set Thomas 30 Hr. Shelf, 48T
- Terry & Andrews, 48T
- Waterbery 8 Day Kitchen, 36T & 42T
- Waterbury School Clock, 42T

Between Plate Verges



Fully assembled between the plate verges. Crutch wire is sent straight and has to be formed.

- | Part No. | Movements |
|----------|-------------------------------|
| 79.060 | Seth Thomas # 89 |
| 79.061 | Sessions |
| 79.062 | Ansonia Kitchen |
| 79.063 | Ansonia School front Pendulum |
| 79.064 | Ansonia "A" Rear Pendulum |
- \$ 7.50 ea.

UNIVERSAL VERGE

Actual Size, Distant between pallet .740"



CV79.052 \$ 5.50 ea.

VERGE STYLE # 2

- Ansonia 30 Hr. Beehive, 46T
- Ansonia 30 Hr. Kitchen, 32T
- Ansonia 8 Day Kitchen, 46T
- Ansonia Brass & Glass, 39T
- Birge & Mallory Strap Movt., 32T
- Canada Clock Co. School Clock, 39T
- C. Jerome 30 Hr. Steeple, 35T
- E.N. Welch 30 Hr. Shelf, 39T & 34T
- E.N. Welch Sch. Clock, 32T & 39T
- Gilbert 8 Day Shelf, 39T & 36T
- Gilbert Regulator, 36T
- Geo. B. Owens 8 Day Shelf, 39T
- Ingraham School Clock, 31T & 39T
- Japanese School Clock, 33T
- New Haven Mantle Clock, 45T
- Sessions School Clock, 39T
- Waterbury Cal. Sch. Clock, 34T & 44T
- Waterbury School Clock, 39T
- Waterbury 30 Hr. Kitchen, 50T
- Waterbury 8 Day Kitchen & Steeple, 39T
- Unmarked Kitchen Movt., 33T
- Unmarked 8 Day Shelf, 36T

UNIVERSAL VERGE

Actual Size, Distant between pallet .780"



CV79.053 \$ 5.50 EA.

VERGE STYLE #3

- Ansonia 30 Hr. OG, 42T
- E.N. Welch 30 Hr. OG, 42T
- Jerome Bank Regulator, 38T
- Jerome 30 Hr. OG, 42T
- Johnson 30 Hr. OG, 42T
- New Haven 30 Hr. OG, 42T
- New Haven School Clock, 39T
- New Haven School Clock, 41T
- New Haven School Clock, 42T
- New Haven Regulator, 42T
- Seth Thomas 8 Day Shelf, 40T
- Seth Thomas 30 Hr. OG, 42T
- Terry & Andrews Lyre Movt., 42T
- Waterbury 30 Hr. OG, 42T
- Unmarked 8 Day X Large Movt. 45T
- Unmarked 30 Hr. OG, 42T

BRASS VERGE PIN PLATE



W/ Steel Pin. 2 PC. PER PKG.
CV79103 \$ 2.00 pkg.
3 or more \$ 1.75 ea..

Old English Escape Wheel



Old English Tall Case escape wheel with Hub. 30 tooth wheel. 1.790" diameter.
79.362 \$10.50 ea.

Brass Escape Wheel



wheel dia. No teeth

79.626	26 mm	26	\$ 5.25 ea.
79.627	27 mm	27	\$ 5.25 ea.
79.628	28 mm	28	\$ 5.25 ea.
79.629	29 mm	29	\$ 5.25 ea.
79.630	30 mm	30	\$ 5.25 ea.
79.631	31 mm	31	\$ 5.25 ea.
79.632	31 mm	32	\$ 5.25 ea.
79.633	31 mm	33	\$ 5.25 ea.
79.634	31 mm	34	\$ 5.25 ea.
79.635	31 mm	35	\$ 5.25 ea.
79.636	32 mm	36	\$ 5.25 ea.
79.637	32 mm	37	\$ 5.25 ea.
79.638	32 mm	38	\$ 5.25 ea.
79.639	32 mm	39	\$ 5.25 ea.
79.640	32 mm	40	\$ 5.25 ea.
79.641	33 mm	41	\$ 5.25 ea.
79.642	33 mm	42	\$ 5.25 ea.
79.643	33 mm	43	\$ 5.25 ea.
79.644	33 mm	44	\$ 5.25 ea.
79.645	33 mm	45	\$ 5.25 ea.
79.646	34 mm	46	\$ 5.25 ea.
79.647	34 mm	47	\$ 5.25 ea.
79.648	34 mm	48	\$ 5.25 ea.
79.649	34 mm	49	\$ 5.25 ea.
79.650	35 mm	50	\$ 5.25 ea.
79.651	35 mm	51	\$ 5.25 ea.
79.652	35 mm	52	\$ 5.25 ea.
3 or more mix or match			\$ 5.00 ea.

Arbors With Lantern Pinion



Arbors are 2" long with Brass hub for easy mounting of wheels. Brass shrouds hold the steel lantern pinions. These arbors can be used to replace missing or broken pinions, also to change pendulum length.
43.906 6 Leaf \$ 3.25 ea.
43.907 7 Leaf \$ 3.25 ea.
43.908 8 Leaf \$ 3.25 ea.
43.909 9 Leaf \$ 3.25 ea.
43.910 10 Leaf \$ 3.25 ea.

Brass hubs For Wheels



Brass hubs for Excape Wheel & other Wheels. .420" dia. X 1.00" thick with .07" hole in center. For mounting on arbors.
79.360 \$ 1.00 ea.

Verge Adjusting Tool

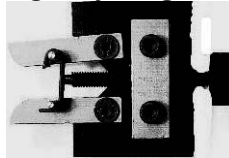

79.065 \$ 62.50

VERGE WIRE RETAINERS



Unformed verge wires, so they can be formed to fit most clocks.
CV79.202 2 Pc. Per Pkg. ... \$ 2.00 ea.

PALLET JEWELS



Sizes 42 to 53 by Drill Size
Ruby color jewels for Brocot Escapements

No.	Drill size	No.	Drill Size
PJ76042	... 42	PJ76048	... 48
PJ76043	... 43	PJ76049	... 49
PJ76044	... 44	PJ76050	... 50
PJ76045	... 45	PJ76051	... 51
PJ76046	... 46	PJ76052	... 52
PJ76047	... 47	PJ76053	... 53

\$ 11 .00 EA. 2 or more \$ 10.75 ea.

Hulsey's Verge Gauge

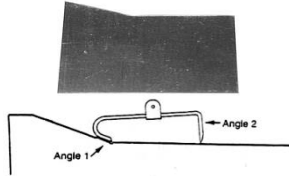

Hulsey's Verge Gauge is used to check the proper angle of a verge. 1 set of Instruction on how to use the Gauge is included.

CV 79.080 \$ 9.75 ea.

COUNT WHEEL RETAINER



MADE OF BRASS, 2 PER PKG.
CW 79200 \$ 2.00 Pkg.

Escape Wheel Bridge



Preformed and Bent. 1-1/2" Long
Made of Brass
79.620 \$ 1.50 Ea.

Hermle Pendulum Leaders

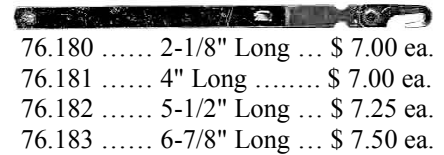

76.180 2-1/8" Long ... \$ 7.00 ea.
76.181 4" Long \$ 7.00 ea.
76.182 5-1/2" Long ... \$ 7.25 ea.
76.183 6-7/8" Long ... \$ 7.50 ea.

Pendulum Leaders



76.184 5-1/2" Long ... \$ 7.50 ea.

Urgos Auto Beat Pendulum Leader



76.179 6-7/8" \$ 4.75 ea.

Hermle Pendulum Leader

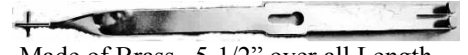

Made of Brass 5-1/2" over all Length
76.178 \$ 8.50 ea

Kieninger Pendulum Leader



7" Brass Leader
76.177 \$ 9.75 ea.

Gut For Clocks



Animal Gut for restoring antique, weight driven clocks. No. 72.160 ,72.170 & 72.180 are in rolls 16 ft long. No 72.518, 72.517 & 72.512 are in rolls of 2 pieces of 11 ft each.

Part No.	Size in mm	Price
72.16060 mm....	\$ 12.75 ea.
72.170	... 21 ga. 70 mm	\$ 13.50 ea.
72.180	... 20 ga. 80 mm	\$ 16.25 ea.
72.190	... 19 ga. 90 mm	\$ 17.50 ea.
72.518	... 18 ga. 1.00 mm ..	\$ 23.75 ea.
72.517	... 17 ga. 1.15 mm ..	\$ 26.25 ea.
72.512	... 14 ga. 1.60 mm ..	\$ 37.25 ea.
72.515 1.80 mm ..	\$ 42.35 ea.
72.516 2.00 mm ..	\$ 52.25 ea.

Kieninger & Urgos Cable Ends



72.481 72.482

Cable ends for Kieninger & Urgos cable They can be used to repair or make a cable To any length. There are 6 pieces per pkg.
72.481 ... Kieninger... \$ 2.25 pkg.
72.482 ... Urgos..... \$ 2.25 pkg.

BRASS CABLE



Part no.	Size	Length	Price
1/32" Cable Breaking Strength 40 lb.			
72.450	1/32"	11 ft ...	\$ 5.50 ea.
72.455	1/32"	30 ft ...	\$ 13.50 ea.
72.478	1/32"	100 ft. .	\$ 38.00 ea.
3/64" Cable Breaking Strength 85 lb.			
72.460	3/64"	11 ft. ...	\$ 4.50 ea.
72.465	3/64"	30 ft. ...	\$ 11.25 ea.
72.475	3/64"	100 ft. .	\$ 32.50 ea.
.040" Cable Breaking Strength 85 lb.			
72.400	.040"	11 ft. ...	\$ 4.50 ea.
72.430	.040"	30 ft. ...	\$ 11.25 ea.
72.440	.040"	100 ft. .	\$ 32.50 ea.
.055" Cable Breaking Strength 120 lb.			
72.451	.055"	11 ft. ...	\$ 5.75 ea.
72.452	.055"	30 ft. ...	\$ 14.00 ea.
72.453	.055"	100 ft. .	\$ 40.00 ea.
1/16" Cable Breaking Strength 150 lb.			
72.461	1/16"	11 ft. ...	\$ 5.75 ea.
72.466	1/16"	30 ft. ...	\$ 14.00 ea.
72.476	1/16"	100 ft. .	\$ 40.00 ea.
5/64" Brass Cable Breaking Strength 300 lb.			
72.471	5/64"	11 ft.	\$ 7.00 ea.
72.473	5/64"	30 ft.	\$ 17.25 ea.
72.474	5/64"	100 ft.	\$ 50.50 ea.

HERMLE READY MADE BRASS CABLE



Brass cable with ends 1.00 mm (.040")

Cable 53-1/2" long

72.767 \$ 6.00 ea.

Cable 61" long fits 351 movement

72.768 \$ 6.25 ea.

Cable 76-1/2" long

72.769 \$ 6.75 ea.

Cable 79" long

72.770 \$ 6.75 ea.

Cable 88-1/2" long fits 461/1161 movement.

72.790 \$ 7.00 ea.

Cable 105-3/4" long fits 471/1171 movement.

72.708 \$ 7.75 ea.

CABLE ENDS



HERMLE CABLE ENDS

Three of each pieces in a package. Enough to do one set of cables for a clock.

Crimp to install on cable.

72.480 \$ 3.00 pkg.

Prices Subject To Change Without Notice

KIENINGER READY MADE BRASS CABLE



Brass cable with ends 1.00 mm (.040")

Cable is 51" Long.

72.775 \$ 4.50 ea.

Cable is 60" Long.

72.779 \$ 4.75 ea.

Cable is 76" long. Fits KSU/KS/RSU RWS & MSU Movement.

72.776 \$ 5.50 ea.

Cable is 90.5" long

72.777 \$ 6.50 ea.

Cable is 112" long. Fits HTU,HSU,&HS

72.778 \$ 7.75 ea.

URGOS READY MADE CABLE



Brass cable with ends 1.00 mm (.040")

Urgos readymade cable for UW 3 & 66. 105-3/4" Long

72.706 \$ 7.50 ea.

Urgos readymade cable for UW 32. 53" Long

72.753 \$ 5.00 ea.

Chain Hooks And Rings



Cuckoo chains and hook sets. 12 pc. 6 hooks and 6 rings.

79.280 ... 1Day Hooks..... \$ 2.00 pkg.

79.281 ... 8 Day Hooks ... \$ 2.00 pkg.



Grandfather and Grandmother chain ends

Package of 1 hooks , 1 ends and 1 rings

79.285 \$ 3.00 pkg.

CLOCK CHAINS



Regula 1 Day cuckoo Chain. 61 LPF. .90 mm Wire Dia. 70" long Chain only

72.540 \$ 3.50 ea.

3 or more pieces \$ 3.25 ea.



Regula 8 Day cuckoo Chain. 48 LPF. 1.05 mm Wire Dia. 70" long Chains only.

72.543 \$ 4.00 ea.

3 or more pieces \$ 3.75 ea.

CLOCK CHAINS



Hubert Herr 1 Day cuckoo Chains.

59 LPF. .90 mm Wire Dia. 78" Long

72.539 \$ 8.25 ea.

3 or more pieces..... \$ 8.00 ea.



Hubert Herr 8 Day cuckoo Chains.

45 LPF. 1.30 mm Wire Dia. 70" Long

72.545 \$ 11.00 ea.

3 or more pieces \$ 10.75 ea.



Clock Chain. 43 LPF. 1.20 mm Wire Dia. 70" long Chains only.

72.550 \$ 7.75 ea.

3 or more pieces \$ 7.50 ea.



Clock Chain. 52 LPF. 1.05 mm Wire Dia. 70" long Chains only.

72.552 \$ 6.00 ea.

3 or more pieces \$ 5.75 ea.



Hermle Chains

47 LPF. 1.70 mm Wire Dia. 57" Long

72.544 \$ 13.50 ea.

3 or more \$ 13.25 ea.



Kienger Chain

38LPF 1.60 mm Wire Dia. 63" Long

72.547 \$ 11.00 ea.

3 or more \$ 10.75 ea.



Urgos chain for UW 3.

40 LPF. 1.80 mm Wire Dia. 63" long.

72.546 \$ 17.00 ea..

3 or more \$ 16.75 ea.



Ladder Chain

42 LPF 1.20 mm Wire 72" Long

This Ladder chain can be used on Waterbury, Session and New Haven Clocks

72.551 \$ 13.50 ea.

2 or more \$ 13.25 ea.



Ladder Chain

39 LPF 1.20 mm Wire 72" Long

72.559 \$ 14.00 ea.

2 or more \$ 13.75 ea.

Kieninger Cable Guard



Cable Guard Screw
72.217 \$ 2.25 ea.

Kieninger Cable Guard

For KSU, RSA,KS,RWS & PS

Movements.

Plastic Cable guard 1 3/4" Dia.
72.218 \$ 3.75 ea

Plastic Cable Guard 2-1/4" Dia.

For HTU,HSU & HS Movements.

72.219 \$ 4.25 ea.

Hermle Cable Guard



72.325 72.324

1 7/8" Dia. 1 17/32" Dia.

Hermle Cable Guard Plastic

72.324 \$ 4.25 ea.

72.325 \$ 3.75 ea.

Hermle Retainer



Chain Wheel retaining washer for Hermle
Winding wheel. pkg. of 2 pc.

72.905 \$ 1.00 pkg.

3 or more pkg. \$.75 pkg.

Kieninger Retainer



Friction washer for Kieninger cable drum.
pkg. of 2 pc.

72.904 \$.75 pkg.

3 or more pkg. \$.65 pkg.

Chain Wheel

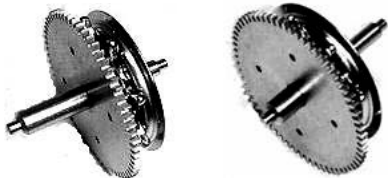

80.100

80.101

Time & Chime Side

Strike Side

New style chime wheel for Keininger
SKS movements.

80.100 Time & Chime \$ 15.25 ea.

80.101 Strike Side \$ 15.25 ea.

Cuckoo Chain Wheel



1 day Time Side for Regula # 25

80.102 ... 19.5 mm PL. ... \$ 7.75 ea.

80.105 ... 23.5 mm PL. ... \$ 7.75 ea.

80.106 ... 28.5 mm PL. ... \$ 7.75 ea.

1 day Strike Side Regula #25



Chain wheel for Regula # 25 Strike Side

80.103 \$ 7.75 ea.

8 day Time & Strike Regula # 34



Chain wheel for Regula # 34 Time &
Strike.

80.104 \$ 9.75ea.

Pulleys



Pulley for Kieninger movements.

76.634 1-3/4 dia. ... \$11.75 ea.

Pulleys



Pulley for Hermle movements.

76.635 1-3/4" dia. ... \$ 14.75 ea.

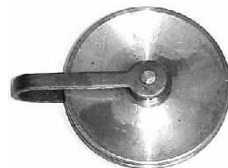

Hall Clock Pulley .

76.705 1-1/2" dia. \$ 9.00 ea.

76.706 1-3/4" dia. \$ 9.00 ea.

S Hooks Nickel Plated



76.707 5/8" \$ 0.40 ea.

76.708 7/8" \$ 0.40 ea.

76.709 1-1/4" \$ 0.40 ea.

12 or more \$ 0.30 ea.

Vienna Regulator Pulley



1-1/8" Diameter Pulley. 5 Spokes

76.636 \$ 6.75 ea.

Vienna Regulator Pulley



1-1/4" Diameter Pulley. 4 Spokes

76.637 \$ 5.75 ea.

Vienna Regulator Pulley Fancy



Fancy Brass Pulley 1-1/8" with cable guard.

76.638 \$ 7.50 ea.

Seth Thomas # 2 & 3 Regulator Pulley

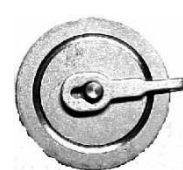

76.639 ST #2



76.640 & 76.641

Pulley for # 2 Regulator 1" Brass

76.639 \$ 5.50 ea.

Pulley for # 3 Regulator 1-1/8" in Brass
And Nickel.

76.640 Brass \$ 11.00 ea.

76.641 Nickel \$ 11.50 ea.

Prices Subject To Change Without Notice

CLICK WITH RIVETS ASSORTMENT



Assortment has 8 Brass Click 4 Ansonia, 4 Waterbury click and 8 Rivets.
72.595 \$ 5.25 ea.

Clicks



72.731 72.738 72.781 72.685
72.731 \$ 2.15 ea.
72.738 \$ 2.15 ea.
72.781 \$ 2.00 ea.
72.685 \$ 2.00 ea.

Cuckoo Chain Wheel Repair Kit



72.402 ... Detent ... \$ 4.00

CUCKOO CHAIN WHEEL REPAIR KIT



Cuckoo clock chain wheel repair kit
72.401 ...Small Click.... \$ 3.50 ea.
72.403 ...Large Click.... \$ 3.75 ea.

Gathering Pallets



79.342 Left



79.343 Right

Used on Tall Case clocks.
79.342 \$ 18.50 ea.
79.343 \$ 18.50 ea.
Mix or match 2 or more ... \$ 18.00 ea.

Click Springs

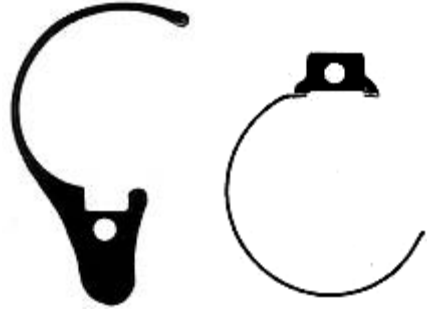

72.601 \$ 4.75 72.602 \$ 5.50



72.631 \$ 4.75

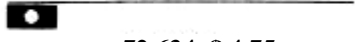

72.634 \$ 4.75



72.633 \$ 4.75



72.635 \$ 4.75



72.636 \$ 4.75



72.632 \$ 5.50 72.675 \$ 5.50 72.676 \$ 5.50

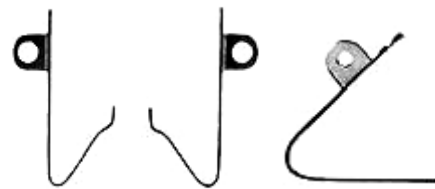

72.716 \$ 5.50 72.717 \$ 5.50 72.674 \$ 5.50



72.784 \$ 4.75



72.785 \$ 4.75



72.157 \$ 5.50

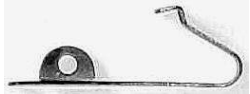

72.158 \$ 5.50

Click Springs



72.604 \$ 4.75 72.607 \$ 4.75



72.611 \$ 4.75 72.660 72.661



72.662 72.663 72.664



72.665 72.666

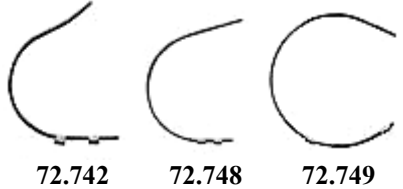

72.742 72.748 72.749



72.756 72.780

Click Spring listed are \$ 4.75 ea.

Tall Case Click Main Wheel

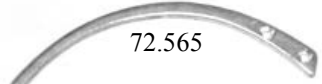

72.565

Brass Click Spring for Tall Case clock Main Wheel.

72.565 \$ 3.00 ea.

Tall Case Return Spring



72.566 \$ 3.50 ea.

Prices Subject To Change Without Notice.

Heavy Click with Spring and Rivets



Six click with spring attached, 3 Lefts & 3 Rights. For American clocks.
72.591 \$ 5.00 pkg.

American Clock

Click with Spring and Rivets
For Gilbert and Ingraham Clocks



Click are made of Brass, each set has 2 clicks & 2 rivets. Spring are attached to click.

72. 596 ... Gilbert..... \$ 3.75 Set
72. 609 ... Ingraham \$ 3.75 Set

Click with Spring and Rivets
For Sessions Clocks



Click are made of Brass, each set has 2 clicks & 2 rivets. Spring are attached to click.

72. 597 \$ 3.75 Set



**Ansonia & Waterbury
CLICK SPRING**

Ansonia (Large) 72.592
Waterbury 72.594
Set of 2 Brass Click, 2 Formed Spring,
and 2 rivets. For Ansonia clocks and
other clock movements.

72.592 \$ 3.75 set.
72.594 \$ 3.75 set



CLICK SPRINGS Set of 2

Set of 2 Brass Click, 2 Formed Spring,
and 2 Rivets.
72.593 ...Seth Thomas (Old).... \$ 3.75 set.
72.600 ...Seth Thomas (New)...\$ 3.75 set.
72.599 ...Ansonia (Small) \$ 3.75 set.
72.608 ...New Haven \$ 3.75 set.

CLICKS



Click with Springs and Rivets
Popular sizes and styles for most clock
Repairs. Set contains three each right
and left. Assortment of six.
72.590 \$ 4.75 pkg.

Kieninger Click Springs



Kieninger Click Spring for RWS & J
Movement. Spring 1 3/8" long for RSU
Spring 1-1/16" for J Movements.
72.691 ... 1-3/8" RSU... \$ 3.75 ea.

72.697 ... 1-1/16" J \$ 4.00 ea.

Hermle Click Spring



72.692 13/16"



72.693 29/32"



72.694 1-1/32"



72.695 2-7/16"

Sold in packages of 3 spring of the same
number to a package.
\$ 3.50 pkg. 3 or more pkg. \$ 3.25 pkg.

Hermle Click Spring Assortment



The assortment of 12 pc.of Hermle click
spring contains 3 each of the Hermle click
spring shown above.

72.696 \$ 13.75 pkg.
3 or more pkg. \$ 13.50 pkg.

**CUCKOO CHAIN WHEEL
CLICK SPRINGS**



79.300 left 79.301 right

Click spring for cuckoo chain wheel. Sold
In packages of 2 per number.
79.300 Left for Time side \$ 2.00 pkg.
79.301 Right for strike side ... \$ 2.00 pkg.
79.302 .. 1 each L & R \$ 2.00 pkg.
3 or more pkg. \$ 1.75 pkg.

-12-

Prices Subject To Change Without Notice.

Click Rivets



Package 25 pc. To a bag
72.560 \$ 3.50 ea.

Wood Base Pocket Watch Display

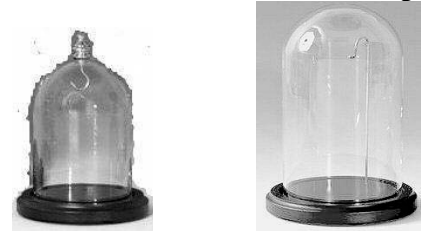

73.902 and 73.903 73.907 and 73.908
Wood bases with hooks to display
pocket watches or other items.

73.902 ... Oak ...hook in top \$ 11.75 ea.
73.903 ... Walnut .. hook in top ... \$ 11.75 ea.
73.907 ... Oak ...hook in base \$ 11.75 ea.
73.908 ... Walnut .. hook in base.. \$ 11.75 ea.

Can mix or Match for Quantity Pricing.
6 to 11 \$ 11.50 ea.
12 and up \$ 11.00 ea.



**Pocket Watch Single Hook
Display, Wood Base.**

Has 3 x 4-1/4 GLASS DOME.
73.900 Oak \$ 9.50 ea.
73.901 Walnut \$ 9.50 ea.
Can mix or Match for Quantity Pricing.
6 to 11 \$ 9.25 ea.
12 and up \$ 8.75 ea.

Golden Hour Glass

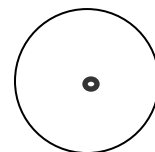

**FLAT GLASS FOR
GOLDEN HOUR CLOCK W/ HOLE**
FGH 700 ... \$ 9.50 EA

Atmos After Market Parts



Atmos suspension spring (spring only)
3517S \$ 18.00 ea.

ROUND CONVEX GLASS

PART NO:	SIZE INCHES
CG 73511	2 1/16
CG 73512	2 1/8
CG 73513	2 3/16
CG 73514	2 1/4
CG 73515	2 5/16
CG 73516	2 3/8
CG 73517	2 7/16
CG 73518	2 1/2
CG 73519	2 9/16
CG 73520	2 5/8
CG 73521	2 11/16
CG 73522	2 3/4
CG 73523	2 13/16
CG 73524	2 7/8
CG 73525	2 15/16
\$ 3.75 EA	

PART NO:	SIZE INCHES
CG 73526	3
CG 73527	3 1/16
CG 73528	3 1/8
CG 73529	3 3/16
CG 73530	3 1/4
CG 73531	3 5/16
CG 73532	3 3/8
CG 73533	3 7/16
CG 73534	3 1/2
CG 73535	3 9/16
CG 73536	3 5/8
CG 73537	3 11/16
CG 73538	3 3/4
CG 73539	3 13/16
CG 73540	3 7/8
CG 73541	3 15/16
\$ 4.25 EA	

PART NO:	SIZE INCHES
CG 73542	4
CG 73543	4 1/16
CG 73544	4 1/8
CG 73545	4 3/16
CG 73546	4 1/4
CG 73547	4 5/16
CG 73548	4 3/8
CG 73549	4 7/16
CG 73550	4 1/2
CG 73551	4 9/16
CG 73552	4 5/8
CG 73553	4 11/16
CG 73554	4 3/4
CG 73555	4 13/16
CG 73556	4 7/8
CG 73557	4 15/16
\$ 4.25 EA	

ROUND CONVEX GLASS

PART NO:	SIZE INCHES
CG 73558	5
CG 73559	5 1/16
CG 73560	5 1/8
CG 73561	5 3/16
CG 73562	5 1/4
CG 73563	5 5/16
CG 73564	5 3/8
CG 73565	5 7/16
CG 73566	5 1/2
CG 73567	5 9/16
CG 73568	5 5/8
CG 73569	5 11/16
CG 73570	5 3/4
CG 73571	5 13/16
CG 73572	5 7/8
CG 73573	5 15/16
\$ 4.25 EA	

PART NO:	SIZE INCHES
CG 73574	6
CG 73575	6 1/16
CG 73576	6 1/8
CG 73577	6 3/16
CG 73578	6 1/4
CG 73579	6 5/16
CG 73580	6 3/8
CG 73581	6 7/16
CG 73582	6 1/2
CG 73583	6 5/8
CG 73584	6 3/4
CG 73585	6 7/8
\$ 4.75 EA	

PART NO:	SIZE INCHES
CG 73586	7
CG 73587	7 1/8
CG 73588	7 1/4
CG 73589	7 3/8
CG 73590	7 1/2
CG 73591	7 5/8
CG 73592	7 3/4
CG 73593	7 7/8
\$ 5.50 EA	

PART NO:	SIZE INCHES
CG 73594	8
CG 73595	8 1/8
CG 73596	8 1/4
CG 73597	8 3/8
CG 73598	8 1/2
CG 73599	8 3/4
\$ 12.00 EA	

OVAL GLASS FOR REVERE

CG 73501	5-13/16" X 4-1/4"	\$ 9.50
CG 73502	7-7/8" X 4"	\$ 11.00
CG 73503	9" X 13"	\$ 22.00

Round High Convex Glass

PART NO:	SIZE INCHES
CG 73658	5
CG 73660	5-1/8
CG 73661	5-3/16
CG 73662	5-1/4
CG 73663	5-5/16
CG 73664	5-3/8
CG 73666	5-1/2
CG 73668	5-5/8
CG 73670	5-3/4
CG 73672	5-7/8
\$ 4.75 EA	
CG 73674	6
CG 73676	6-1/8
CG 73678	6-1/4
\$ 5.00 EA	

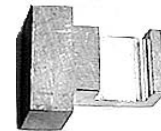

Atmos Front Door Knob for 528 and 540Cal.

5902-528/540	\$ 22.00 ea.
5904-528/540	\$ 22.00 ea.

5904-528/540 this knob is for Atmos glass. But is an aftermarket part.

Front Glass Panel for 528 or 540 Cal.

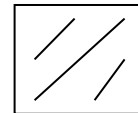

The Glass Panel only for 528 & 540 Cal.

5902G/C 528 ... 6-7/16" X 7-1/8"

4356G/C 540 ... 6-1/8" X 7-9/16

5902G/528 \$ 20.00

4356G/540 \$ 20.00

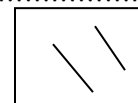

**\$ 5.00
Minimum**

**Rectangle Piece Cut To Your Size
THICKNESS 1/16**

PRICE IS .10 CENTS PER SQ INCH



ROUND CONVEX GLASS

PART NO:	SIZES	PRICE
CG 73900	9"	\$ 12.50 ea.
CG 73925	9 1/4"	\$ 12.50 ea.
CG 73950	9 1/2"	\$ 12.50 ea.
CG 73975	9 3/4"	\$ 12.50 ea.

PART NO:	SIZES	PRICE
CG 73000	10"	\$ 12.50 ea.
CG 73025	10 1/4"	\$ 12.50 ea.
CG 73050	10 1/2"	\$ 12.50 ea.
CG 73075	10 3/4"	\$ 12.50 ea.

PART NO:	SIZES	PRICE
CG 73110	11"	\$ 12.75 ea.
CG 73125	11 1/4"	\$ 12.75 ea.
CG 73150	11 1/2"	\$ 12.75 ea.
CG 73175	11 3/4"	\$ 12.75 ea.

PART NO:	SIZES	PRICE
CG 73212	12"	\$ 13.00 ea.
CG 73225	12 1/4"	\$ 13.00 ea.
CG 73250	12 1/2"	\$ 13.00 ea.
CG 73275	12 3/4"	\$ 13.00 ea.

PART NO:	SIZES	PRICE
CG 73300	13"	\$ 14.00 ea.
CG 73730	14"	\$ 20.00 ea.
CG 73738	14-3/8"	\$ 20.00 ea.
CG 73750	15"	\$ 22.50 ea.
CG 73758	15-7/16"	\$ 22.50 ea.

Beveled Flat Glass



CG 73434	3-1/2"	\$ 5.75 ea.
CG 73435	3-9/16"	\$ 5.75 ea.
CG 73436	3-5/8"	\$ 6.00 ea.

CG 73449	4-7/16"	\$ 9.50 ea.
CG 73450	4-1/2"	\$ 9.50 ea.
CG 73451	4-9/16"	\$ 9.50 ea.
CG 73452	4-5/8"	\$ 9.75 ea.
CG 73455	4-13/16"	\$ 11.00 ea.
CG 73456	4-7/8"	\$ 11.00 ea.

CG 73462	5-1/4"	\$ 12.25 ea.
CG 73464	5-3/8"	\$ 12.25 ea.
CG 73466	5-1/2"	\$ 12.50 ea.
CG 73468	5-5/8"	\$ 12.75 ea.
CG 73470	5-3/4"	\$ 13.00 ea.

We accept these Credit Card
Unless other arrangement are made.

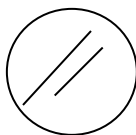

ROUND FLAT GLASS CUT TO SIZE --- THICKNESS - 1/16

SIZES INCHES	PRICE EA
2" TO 2 15/16"	\$ 3.25
3" TO 3 15/16"	\$ 3.75
4" TO 4 15/16"	\$ 4.00
5" TO 5 15/16"	\$ 4.75
6" TO 6 15/16"	\$ 5.75
7" TO 7 15/16"	\$ 6.75
8" TO 8 15/16"	\$ 7.75
9" TO 9 15/16"	\$ 8.50
10" TO 10 15/16"	\$ 9.75
11" TO 11 15/16"	\$10.50
12" TO 12 15/16"	\$11.25
13" TO 13 15/16"	\$12.00
14" TO 14 15/16"	\$14.25

Bezel With Flat Glass



SIZE INCHES	PRICE EA
BZG 400	4" \$ 17.00 ea.
BZG 450	4-1/2" \$ 17.00 ea.
BZG 478	4-7/8" \$ 17.00 ea.
BZG 500	5" \$ 17.50 ea.
BZG 518	5-1/8" \$ 17.50 ea.
BZG 514	5-1/4" \$ 17.50 ea.
BZG 538	5-3/8" \$ 18.00 ea.
BZG 512	5-1/2" \$ 18.00 ea.
BZG 596	5-9/16" \$ 19.00 ea.
BZG 558	5-5/8" \$ 19.00 ea.
BZG 534	5-3/4" \$ 19.00 ea.
BZG 600	6" \$ 19.75 ea.
BZG 618	6-1/8" \$ 19.75 ea.
BZG 614	6-1/4" \$ 19.75 ea.
BZG 638	6-3/8" \$ 20.00 ea.
BZG 612	6-1/2" \$ 20.00 ea.

BEZEL WITH CONVEX GLASS



Part No	Size Inches	Price
BZGC 400	4"	\$ 20.75 ea.
BZGC 450	4-1/2"	\$ 21.25 ea.
BZGC 478	4-7/8"	\$ 21.50 ea.
BZGC 500	5"	\$ 21.75 ea.
BZGC 518	5-1/8"	\$ 22.00 ea.
BZGC 514	5-1/4"	\$ 22.50 ea.
BZGC 538	5-3/8"	\$ 22.75 ea.
BZGC 512	5-1/2"	\$ 23.25 ea.
BZGC 596	5-9/16"	\$ 23.75 ea.

BEZEL WITH CONVEX GLASS



Part No	Size Inches	Price
BZGC 558	5-5/8"	\$ 24.50 ea.
BZGC 534	5-3/4"	\$ 25.00 ea.
BZGC 600	6"	\$ 25.50 ea.
BZGC 614	6-1/4"	\$ 26.00 ea.
BZGC 638	6-3/8"	\$ 26.75 ea.
BZGC 612	6-1/2"	\$ 27.25 ea.



BEZEL ONLY - LESS GLASS

Accessory Pkg. Includes
Glass tabs & Hing. Glass NOT included

SIZES INCHES	PRICE EA
BZ 250	2-1/2" \$ 14.25
BZ 275	2-3/4" \$ 14.25
BZ 318	3-1/8" \$ 14.25
BZ 350	3-1/2" \$ 14.25
BZ 400	4" \$ 15.00
BZ 438	4-3/8" \$ 15.00
BZ 450	4-1/2" \$ 15.00
BZ 475	4-3/4" \$ 15.00
BZ 478	4-7/8" \$ 15.00
BZ 500	5" \$ 15.50
BZ 518	5-1/8" \$ 15.50
BZ 514	5-1/4" \$ 15.50
BZ 538	5-3/8" \$ 15.50
BZ 512	5-1/2" \$ 15.50
BZ 596	5-9/16" \$ 15.50
BZ 558	5-5/8" \$ 15.50
BZ 534	5-3/4" \$ 15.50
BZ 578	5-7/8" \$ 15.50
BZ 600	6" \$ 16.00
BZ 618	6-1/8" \$ 16.00
BZ 614	6-1/4" \$ 16.00
BZ 638	6-3/8" \$ 16.00
BZ 612	6-1/2" \$ 16.00
BZ 700	7" \$ 19.50
BZ 712	7-1/2" \$ 19.50
BZ 858	8-5/8" \$ 20.00
BZ 878	8-7/8" \$ 20.00
BZ 1012	10-1/2" \$ 21.50
BZ 1078	10-7/8" \$ 21.50
BZ 1258	12-5/8" \$ 30.50
BZ 1278	12-7/8" \$ 30.50
BZ 1300	13" \$ 30.50
BZ 1318	13-1/8" \$ 30.50

Prices Subject To Change Without Notice.

All Glass Sizes Are (8" W X 14" H) KITCHEN CLOCK GLASS REPLACEMENTS

Gold Pattern Glass \$ 11.00 ea.

Silver Pattern Glass \$ 12.00 ea.



(6" W X 7" H)
Ansonia
73.621 Gold

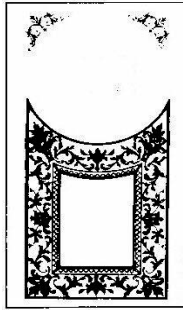

(6 1/8" W X 7 1/8" H)
Ansonia
73.635 Gold



(6" W X 6 7/8" H)
Ansonia
73.640 Gold

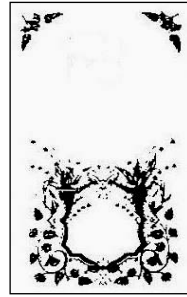

(5 7/8" W X 5 3/8" H)
Gilbert
73.601 Gold

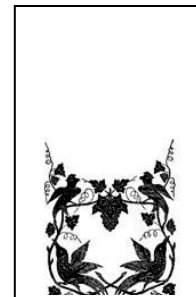

(5 3/4" W X 5 3/8" H)
Gilbert
73.670 Gold



(6-1/4" W X 6 1/2" H)
Gilbert
73.611 ... Gold
73.811 ... Silver



(5-3/4" W X 6-1/8" H)
Ingraham
73.612 Gold



(5 5/8" W X 6 3/8" H)
Ingraham
73.627 Gold



(6-3/8" W X 6-1/2" H)
Ingraham
73.628 Gold

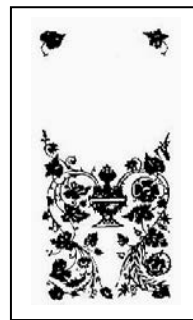

(5 3/4" W X 6 1/8" H)
Ingraham
73.605 Gold

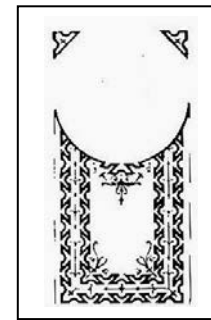

(6 1/8" W X 6 3/8" H)
Ingraham
73.606 Gold

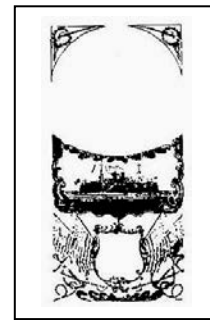

(5-7/8" W X 6-5/8" H)
Ingraham
73.607 Gold

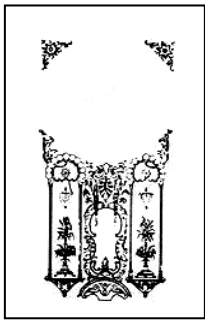

(5-7/8" W X 6-3/8" H)
Ingraham
73.604 Gold
73.804 ... Silver

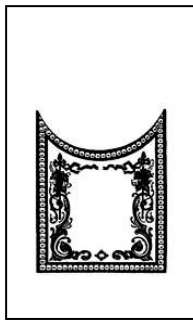

(5" W X 5-1/4" H)
Ingraham
73.668 Gold

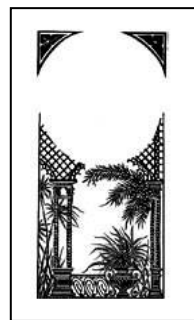

(5-7/8" W X 6-3/8" H)
Ingraham
73.617 Gold

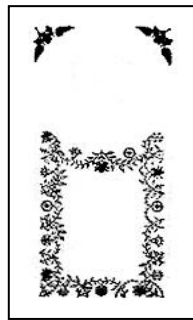

(5-1/8" W X 6-3/4" H)
New Haven
73.615 Gold

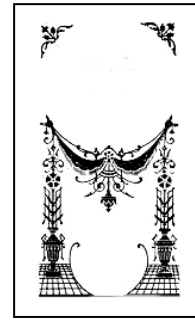

(6-1/2" W X 7" H)
Seth Thomas
73.602 ... Gold

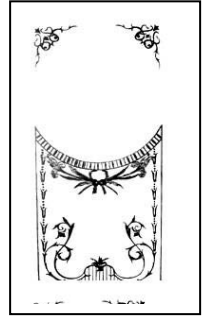

(5-3/4" W X 5-5/8" H)
Waterbury
73.633 Gold

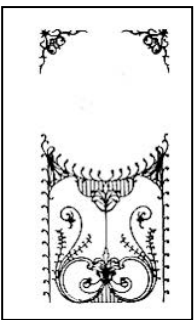

(5-7/8" W X 6" H)
Waterbury
73.630 Gold

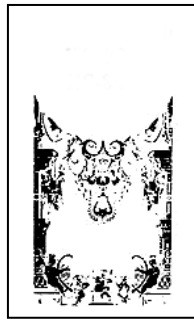

(5 3/4" W X 7" H)
Welch
73.688 Gold

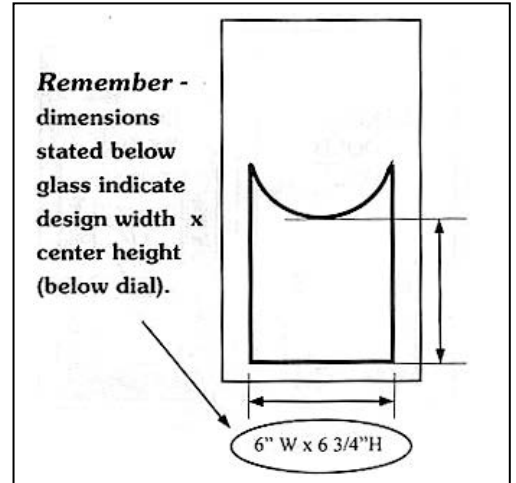
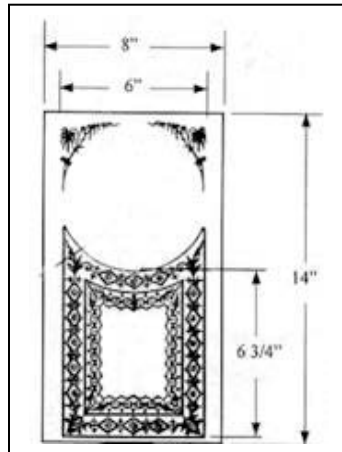

Prices Subject To
Change Without Notice.

Shop Regulator Glass 14" X 16"

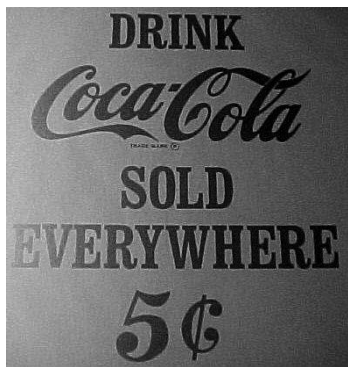

10" Wide X 8-3/4" High
Gold on Clear Glass
73.501 \$ 20.00 ea.



9-1/4" Wide X 9-1/4" High
Gold on Clear Glass
73.502 \$ 20.00 ea.



12-1/2" Wide X 12-3/8" High
Red and Gold
73.503 \$ 20.00 ea.



9-5/8" Wide X 9-5/8" High
Gold
73.504 \$ 20.00 ea.



11-1/2" Wide X 11-1/2" High
Gold
73.505 \$ 20.00 ea.



11-1/4" Wide X 11-1/4" High
Gold
73.506 \$ 20.00 ea.

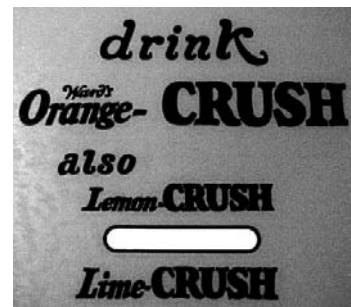

10-3/4" X 9-1/2" High
Orange Background with Black Letters
73.513 \$ 20.00 ea.



12-1/2" Wide X 11-1/2" High
Black Background with Gold Letters
73.514 \$ 20.00 ea.



10" Diameter
Yellow and Green
73.515 \$ 20.00 ea.



11" High X 10-1/4" High
Red on clear Glass
73.516 \$ 20.00 ea.



11" Wide X 10-3/4" High
Red and Black
73.517 \$ 20.00 ea.



11" Wide X 11" High
Background with Red & Blue Letters
73.519 \$ 20.00 ea.



11-1/4" Diameter
Red with White Lettering
73.518 \$ 20.00 ea.

Prices Subject To Change Without Notice.

Multicolored Glass



Beehive

Gold or Silver pattern
Glass is 9" X 12"

Painted area 8" wide X 10" high
73.107 has Gold with black. Has blue and yellow flowers with green leaves. Beehive is brown.

73.107 \$ 18.75

73.108 has Silver with black. Has blue and yellow flowers with green leaves. Beehive is brown.

73.108 \$ 18.75

Multicolored Glass



Flowers

Gold or Silver pattern
Glass is 10" X 12"

Painted area 9" wide X 12" high
5 Color design surrounded by gold scroll work with black background.

73.102 \$ 18.75

Etched Glass



Etched glass for Steeple, Beehive and other American Mantle Clocks. 7" X 8"

73.203 ... Harp Pattern ... \$ 12.00

Prices Subject To Change Without Notice.

**OG Glass
Multicolored Glass**



Grape & Leaves

Glass is 9" X 12"

Painted area 6-7/8" wide X 9-1/16" high

Purple Grapes with green leaves

On an orchid background.

Trim is gold and black

73.100 \$ 18.75

Multicolored Glass



George Washington

Glass is 9" X 12"

Painted area 8" wide X 10" high

Portrait with an medallion surrounded

By a light green border.

73.105 \$ 18.75

Etched Glass

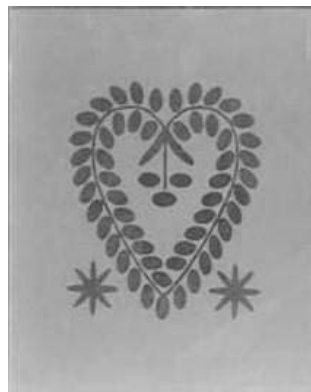

Etched glass for Steeple, Beehive and other American Mantle Clocks. 7" X 8"

73.205 ... Heart Pattern ... \$ 12.00

Multicolored Glass



Sunburst

Glass is 9" X 12"

Painted area 8" wide X 10" high
Red, Blue and Silver design on a black Background and gold scroll.

73.101 \$ 18.75

Regulator Glass

Glass is 8" X 14"

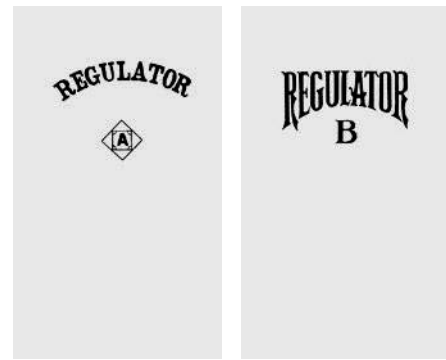

73.507 gold

73.509 Gold

73.508 Silver

73.510 Silver

This glass is for long drop clock case Like Ansonia. But could be use on other regulators by removing the A or B with an razor blade.

\$ 12.00 ea.

Top Shop Regulator Glass

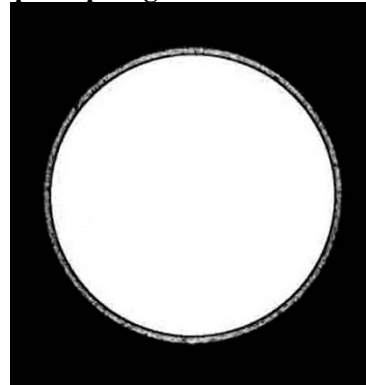

Black background with Gold ring
73.511 ... 11-3/8" opening ... \$ 18.00

73.512 ... 11-3/4" opening ... \$ 18.00

Transfers Trademark

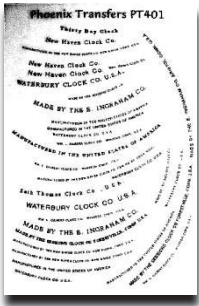

New Haven, Ingraham
Waterbury
3/32" to 1/8" High
73.341

Waterbury, Ingraham
Session, Ansonia
3/32" to 5/32" High
73.242

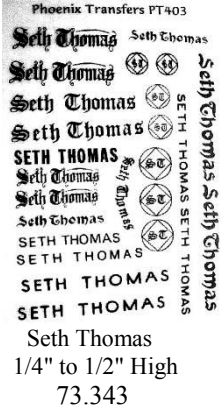

Seth Thomas
1/4" to 1/2" High
73.343

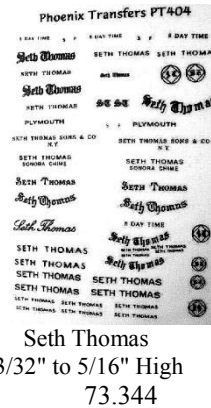

Seth Thomas
3/32" to 5/16" High
73.344



E Howard, Gilbert &
Ansonia
3/32" to 1/2" High
73.345



Ingraham, Ansonia,
E. Howard, Gilbert
3/32" To 5/16" High
73.346



New Haven, Ingraham
1/8" to 9/16"
73.347
\$ 7.50 ea. 3 or more



Session, New Haven
Waterbury
3/32" to 1/2"
73.348
\$ 7.25 ea.

Prices Subject To Change Without Notice.

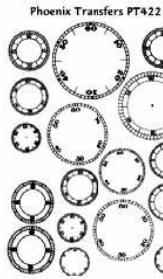

1-5/16" to 2-1/2"
73.342
\$ 7.50 ea. 3 or more

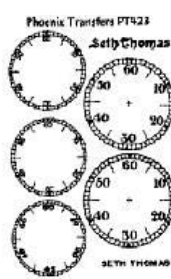

2-9/16" to 3-1/4"
73.323
\$ 7.25 ea.

Regulator Transfer

REGULATOR

1-1/16 High X 7-3/8 Long
73.334



1-5/8" H 4-15/16L
2-5/8" H 4-1/4 L
3-1-13/16" H 2-5/8L
73.335



1" High 4-13/16 L
73.336
3/4" H 5-3/4L
73.337

\$ 5.00 ea. 3 or More \$ 4.75 ea.

French Movement Straps



Straps for mounting French movements
to the case. 6" Long. 2 straps to pkg.
71.043 \$ 7.25 pkg.

Wall Stabilizers



Wall stabilizer with a steel plate and screw
With a Brass Knob.

79.100 Small 1-1/4" screws
79.101 Large 1-1/2" screws
Sold in set of 2 pc
79.100 \$ 7.00 set
79.101 \$ 8.00 set.

Vienna Regulator Wall Stabilizer



Vienna stabilizer made of cast brass
2 pieces in a package.
1-1/4" long Screw Brass plate 1-5/8" long
79.103 \$ 11.50 pr.
3/4" long screw Brass plate 1-3/4" long
79.104 \$ 13.00 pr.

Seat Board Screws Assortment



Seat Board screws with plates for
grandfather Movements.
12 pieces in a package.
74.334 \$ 13.75 pkg.

Seat Board Screws & Hardware



74.435 13/16D 74.436 5/8" WX 2" L

Movement Mounting Screw for
Mounting Movement To Seat Board.
74.330 ... 1-1/8" Long 22 mm Thread
74.331 ... 1-1/2" Long 32 mm Thread
74.332 ... 1-3/4" Long 22 mm Thread
74.333 ... 2-3/8" Long 32 mm Thread
2 in package \$ 3.00 pkg.
74.435 ... Seat Board Washer ... \$ 1.15
74.436 ... Seat Board Strap \$ 1.75

Seat Board Hooks



Used to hold Movement to seat board.
74.336 ... 4-40 Thread ... 2-1/2" long
74.337 ... 6-32 Thread ... 2-7/8" long
74.338 ... 8-32 Thread ... 3-5/8" long
\$ 2.50 each

HAND & GEAR PULLERS

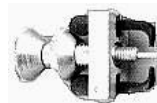

HAND REMOVER & GEAR PULLER
24.581 \$ 21.75



HAND PULLER

24.580 \$ 12.75

Keystone Hand Gear Puller



The Keystone Hand and Gear puller is
Design so you can slide the V groove
under the hands, gear or gathering pallet
and slide the puller arm over the center of what
needs to be removed. The tool is 2" long
3/4" wide X 1" high. Has 3/8" clearance
from bottom of pin to inside V groove.
24.586 \$ 35.00 ea.



CLOCK DOMES

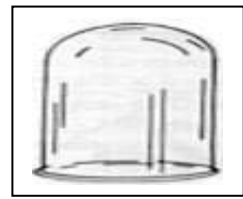

DOMES	L (D)	W	H	DESCRIPTION	MAKER	PRICE
G 2	3"		4 1/4"	Pocket Watch Dome		\$ 5.25
G 3A*	7"	3 7/8"	6 3/8"	Oval		\$ 60.00
G 4	7"	3 3/4"	7"	Oval	Kundo Kern	\$ 60.00
P 5 *	3 7/8"		5 5/8"	Locking Lugs	Schatz	\$ 37.50
G 8 AA	7"	3 7/8"	7 3/8"	Oval	Haller	\$ 60.00
P 9 A	4 1/8"		5 7/8"		Kundo	\$ 28.00
NEW G 9	4"		6"		Kundo	\$ 35.00
G 10	4"		7"		Haller - Kern	\$ 10.00
G 18 A*	4 1/4"	4 1/4"	5 1/2"	Oval	Haller	\$ 50.00
P 19 A*	5 1/4"	4 1/4"	6 1/2"	Red Cap	Schatz	\$ 55.00
G 20 H	** 4 1/4"		7 1/4"	W/ 1" Hole	Schatz	\$ 80.00
G 20 D	** 4 1/4"		7 1/2"	Domestic	Schatz	\$ 78.00
NEW G 29	** 4 1/4"		9"		Holden Electric	\$ 50.00
P 20 A*	4 3/8"		6 7/8"	Locking Lugs	Schatz	\$ 38.00
G 30 D	4 5/8"		8"		Miniature	\$ 12.50
P 30	4 5/8"		8"		Miniature	\$ 12.00
NEW G 32	** 4 3/4"		9"		Kaiser Universe	\$ 48.75
G 33 D	** 5 1/8"		8"		Schatz 1000 Day	\$ 55.00
G 38	** 5 1/2"		7 1/2"	W/ 3/8" Hole In Top	Henn	\$ 65.00
P 39 A	5 1/2"		7 7/8"		Kundo	\$ 30.00
G 39 B	** 5 1/2"		8"			\$ 47.50
NEW G 39 C	** 5 1/2"		9"		Pool Clock	\$ 60.00
NEW G 39 H	** 5 1/2"		9 3/8"	W/ 1" Hole In Top	Schatz Standard	\$ 70.00
G 39 J	5 1/2"		10 "			\$ 18.00
G 40	** 5 1/2"		10 1/2"		Standard	\$ 59.75
G 42 D	5 1/2"		11"		Original Standard	\$ 19.00
G 44	** 5 1/2"		14"			\$ 60.00
P 46 *	5 5/8"		9 1/4"		Masters	\$ 35.00
G 47	** 6"		13"			\$ 87.75
NEW G 60	** 7"		12-1/2"			\$ 88.75
G 70	** 7 1/2"		16"			\$ 152.00
G 72	8"		12"			\$ 35.00
NEW G 95	9 1/2"		16"			\$ 187.50
NEW G98	9 7/8"		15"			\$ 82.50

P = Plastic; G = Glass; D = Domestic; (All others are imported)

* = Out of production, available only while our supply lasts.

**** NOTE: These Domes are hand blown glass and is therefore subject to imperfections such as bubbles, chill lines, "seeds" and striations. This is the character of hand blown glass that make it unique.**

SPECIAL SERVICE:

Drill Hole in top of dome: 1/2" or 1" \$ 10.00 per hole

Prices are subject to change without notice.

HOROLOVAR SUSPENSION SPRING ASSORTMENTS



400 DAY LEVELING FEET



400 day Feet have M4 Thread
 78.075 78.074
 78.074 3/4" Dia. \$ 2.75 ea.
 78.075 1" Dia. \$ 2.75 ea.

HOROLOVAR LONG LIFE



BATTERY

CM 71.010 .. LARGE (# 8 or # 9) .. \$23.00
 CM 71.015 .. Small (#10 or # 3) \$21.00

KUNDO BATTERY ADAPTOR

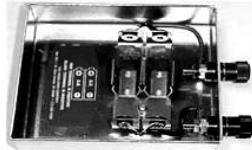

Battery adaptor to replace the # 8 & #9 Battery for Kundo
 71.009 \$ 22.00 ea.

POPULAR ASSORTED STRENGTH











1--.0020" 2--.0023" 1--.0025" 1--.0030"
 2--.0032" 2--.0035" 1--.0037" 2--.0040"
 78.090 \$ 20.00 EA

INTERMEDIATE ASSORTED STRENGTH

1--.0018" 1--.0019" 1--.0021" 1--.0022"
 1--.0024" 1--.0028" 1--.0031" 1--.0033"
 1--.0036" 1--.0038" 1--.0045" 1--.0050"
 78.091 \$ 20.00 EA



400 DAY BLOCKS



price \$ 10.00 ea.

- Y37  Schatz Standard Block No. 78.037
- Y38  Schatz Standard Block No. 78.038
- Y39  Schatz Standard Block No. 78.039
- Y40  Schatz Junior Block No. 78.040
- Y41  Schatz Junior Block No. 78.041
- Y42  Schatz Junior Block No. 78.042
- Y43  Kundo Junior Block No. 78.043
- Y44  Kundo Junior Block No. 78.044
- Y45  Kundo Standard Block No. 78.054
- Y50  Kundo Standard Block No. 78.050

RATCHET WHEEL

\$ 5.00 EA

		
78.338	78.340	78.346
12 mm dia.	12.5 mm dia.	14.5 mm dia.
18 teeth	13 teeth	12 teeth
3.50mm sq	3.50mm sq	6.25H 4.40W

		
78.347	78.357	78.359
15.5 mm dia.	18 mm dia.	18.5 mm dia.
16 teeth	20 teeth	15 teeth
4.10mm sq	4.10mm sq	6.25H 4.40W

400 DAY BEAT SETTING TOOL



This tool takes the work out of beat setting. After tightening the set screw, clamp the Jaws to the saddle or end of suspension unit and starting the pendulum, rotating. The Long arm will enable you to make micrometer adjustment.
 24.565 \$ 21.50 ea.

400 Day wheel

1 st, 2nd & 3 rd wheel ... \$ 15.75 ea
 Center wheel \$ 18.75 ea
 Escape wheel \$ 20.00 ea
 Verge.....\$ 20.00 ea

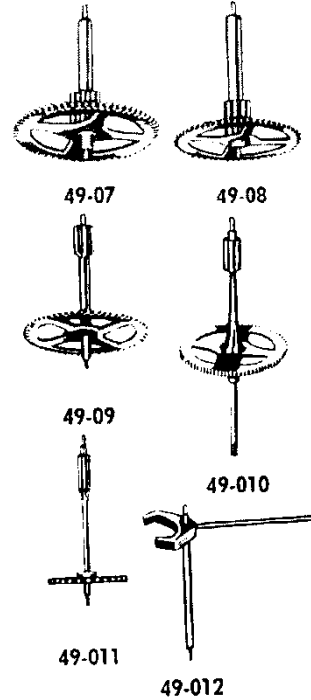

Need to know make of clock for the gear.

400 Day Suspension Spring Fixture



Assembly Fixture for 400 day suspension springs
 24.568 \$ 49.50 ea.

400 Day Suspension Spring Fixture

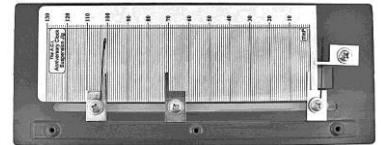

Assembly Fixture for 400 day suspension Springs. Spring clips help hold top & Bottom blocks. From Enguland.
 24.564 \$ 58.50 ea.

We accept these Credit Card Unless other arrangement are Made.



Price subject to change without notice.

400 DAY SUSPENSION SPRINGS

HOROLOVAR SUSPENSION SPRING UNITS-These are completely assembled with blocks and fork, and are guaranteed accurate for the clock and model specified.

Horolovar		Horolovar	
No.	No.	No.	No.
78.200	1	78.235	28C
78.203	3C	78.236	29A
78.204	5A	78.237	29B
78.205	5B	78.238	31
78.206	5E	78.239	32
78.207	5F	78.240	33
78.208	6789	78.242	35
78.209	IOA	78.243	36B
78.210	10B	78.245	38A
78.211	10C	78.248	40B
78.212	11A	78.249	41B
78.213	11B	78.250	42A
78.214	12C	78.251	43A
78.215	12D	78.253	45A
78.216	12E	78.254	46A
78.217	12F	78.260	50B
78.218	13B		
78.219	13C		
78.220	14A		
78.221	14B		
78.222	16		
78.223	18C		
78.224	20A		
78.225	20B		
78.226	23A		
78.227	23B		
78.228	25A		
78.229	25B		
78.230	27A		
78.231	27B		
78.232	27C		
78.233	28A		
78.234	28B		



**Price per units \$ 33.50 ea.
3 or more \$ 33.25 ea**

HOROLOVAR SUSPENSION SPRING ONLY 3 per package

78.1180018 in046 mm	78.1320032 in081 mm
78.1190019 in048 mm	78.1330033 in084 mm
78.1200020 in051 mm	78.1340034 in086 mm
78.1210021 in053 mm	78.1350035 in089 mm
78.1220022 in056 mm	78.1360036 in091 mm
78.1230023 in058 mm	78.1370037 in094 mm
78.1240024 in061 mm	78.1380038 in097 mm
78.1250025 in064 mm	78.1400040 in102 mm
78.1280028 in071 mm	78.1450045 in114 mm
78.1300030 in076 mm	78.1500050 in127 mm
78.1310031 in079 mm	78.1550055 in140 mm
	78.1600060 in152 mm

**PRICEon Numbers 78.118 to 140
is \$ 5.00 ea.**

3 or more \$ 4.75 ea.

**PRICEon Numbers 78.145 to 160
is \$ 5.50 ea.**

3 or more \$ 5.25 ea.



400 Day Pendulum



Rotary pendulum drive mechanism for 400 day clocks or other Clocks.
Has 2-3/4" diameter rotary pendulum.
Uses one AA battery.

BATTERY NOT INCLUDED.

15.980 ... Movement ONLY \$ 9.25
15.981 ... Pendulum ONLY \$ 3.00
15.982 ... Movement W/Pend ... \$ 12.00

Quartz Dual Chime Movement

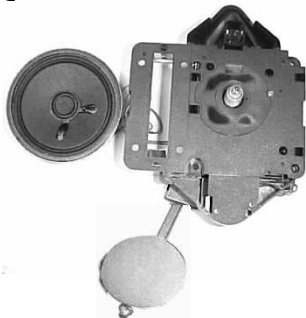

Dual Chime movement with remote speaker. Comes with break a way pendulum & mounting hardware. Plays two melody Westminster & Whittington. Night Silencer switch. Takes one "C" battery. Hand Shaft is 5/16" .

Movement size 3-3/4 wide X 4-3/8 high X 1-1/16 deep.

HANDS NOT INCLUDED & Batteries Not Included

74.146 ... 1/4 Dial ... 11/16 Shaft Length
74.147 ... 3/4 Dial ... 1-3/16 Shaft Length
\$ 44.50 ea.

3 or more mix or match \$ 44.25 ea.

Radio Controlled Quartz Movement



Radio Controlled Atomic quartz Movement it Automatically set itself from and signal from Fort Collins, Colorado.

Movement size 2-3/16" W X 3-5/8" H X 5/8" D
Mounting Hardware Included

Batteries Not Included

HANDS NOT INCLUDED

15.473 15/32" shaft \$ 13.75 ea.
15.474 11/16" shaft \$ 13.75 ea.
6 or more \$ 13.50 ea.

Prices Subject To Change Without Notice

QUARTZ BIM-BAM ON RODS

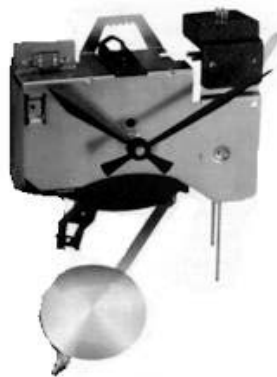

Shaft fits dials up to 5/16" Movement size is 7" High X 5-7/8" Wide By 2" Deep
Takes A "D" battery (not included).
Pendulum rod adjustable to 15-1/8"
This movement will work With the pendulum or without pendulum.
Mounting Hardware Included.

Hands Not Included.

Batteries Not Included

QBB60 \$ 80.00 ea.
3 or more \$ 79.75 ea.
6 or more \$ 79.50 ea.

24 HR QUARTZ MOVEMENT

24-HOUR MOVEMENT

The hour hand makes one complete revolution every 24 hours. Start a business line showing the military and European way of telling time.

- Requires one "AA" battery

Shaft diameter is 5/16"
Accommodates Dial up to 1/4"
2-1/4" H X 2-1/4" W X 3/8" D

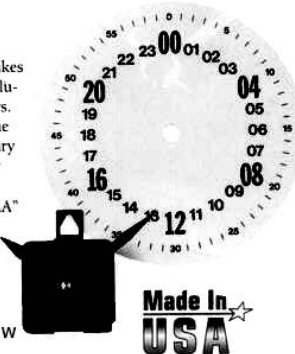

Batteries Not Included

Hardware And Hands Included

Part No.	Price
HTAA160 ... 1 TO 5	\$ 6.00 ea.
6 & UP	\$ 5.75 ea.
DI085 ... 6 1/2" dial 1 TO 5	\$ 3.25 ea.
6 & UP	\$ 3.00 ea.

Quartz Minute Hand Nut Driver



Spring loaded nut driver. All metal. Can be used to put Minute hand nuts on quartz movement or crown winder for Watches. Also works good to hold Small Nuts.
Made in France.

58.215 \$ 19.50 ea.

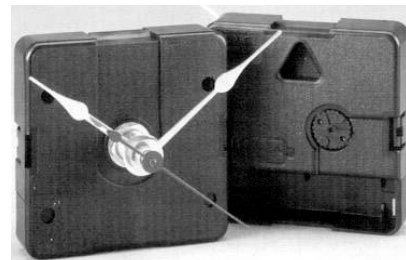

American Engineered Quartz Movements

One "AA" Battery required,

Movement comes with

Hands & Mounting Hardware Included. Batteries Not Included

Part no.	Dial Thickness	Shaft length
QMA316	3/16"	5/8"
QMA140	1/4"	11/16"
QMA380	3/8"	7/8"
QMA150	1/2"	15/16"
QMA340	3/4"	1-3/16"
1 to 4		\$ 4.50 ea.
5 to 9		\$ 4.25 ea.
10 to 24		\$ 4.00 ea.
25 to 49		\$ 3.75 ea.
50 or more		\$ 3.50 ea.

AA Quartz Push On Hands

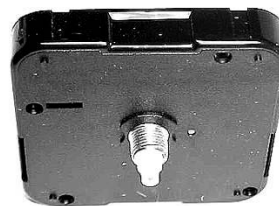

Push-on Mounting with bushing. Threaded bushing will ensure the clock will continue to be tightly secured to the dial.

Movement size 2-3/16" Square X 11/16" D
Hand And Batteries Not Included

Part No	Dial Thickness	Shaft Length	Price
CM 700	1/8"	1/2"	\$ 4.50 ea.
CM 740	1/4"	3/4"	\$ 4.50 ea.
		5 to 9	\$ 4.25 ea.
		10 to 24	\$ 4.00 ea.

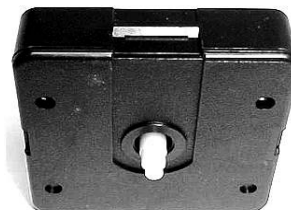

Push-On Mounting. No Hardware needed just snap in and push on the hands.

Movement size is 2-7/32" Sq. X 5/8" D

Hands And Batteries Not Included

Part No.	Dial Thickness	Shaft Length	Price
CM 046	1/8"	3/8"	\$ 4.50ea.
CM 059	5/16"	9/16"	\$ 4.50 ea.
		5 to 9	\$ 4.25 ea.
		10 to 24	\$ 4.00 ea.

Reverse Time Quartz Movement



Dials on pg 35

Now you can have time running backwards
Movement is 2-1/4" X 2-1/4" X 5/8 " deep
Shaft is 11/16" or 1-3/16" Long.

Takes one AA Battery.
Mounting Hardware Included

**Batteries Not Included
HANDS NOT INCLUDED**

15.350 ...1/4" dial 5/8" shaft... \$ 7.75 ea.
6 or more \$ 7.50 ea.



Pendulum PG 4

Pendulum case for AA Quartz Movements.
Can use High torque or Standard AA
Movements. Case is 2-3/8" W X 2-1/2" H
1-1/4"D Requires 1 AA battery not Included.
15.214 \$ 8.50 ea.

CONTINUOUS-SWEEP MOVEMENT



AA continous-sweep movement. Second
hand moves smoothly around dial.
Mounting Hardware. **Hands Not Included.**

Batteries Not Included

Movement size: 2-1/8" H X 2-1/8 W
X 5/8 D. Brass shaft accommodates dial
1/4" thick & 1/2" thick
74.140 ... 1/4" dial 5/8" shaft \$ 6.75 ea.
74.141 ... 1/2" dial 7/8" shaft... \$ 6.75 ea.
6 and up \$ 6.50 ea.



"AA" HIGH TORQUE

"AA" Battery Quartz Movement
Mounting Hardware Included.

Hands Not Included. Batteries Not Included

Case dimensions 2-7/32 Square X 5/8 thick.
Dial Thickness PRICE
QHTA 250 ...3/8" dial 11/16 shaft \$ 8.75 ea.
QHTA 750 ...3/4" dial 1-3/16 shaft \$ 8.75 ea.
6 to 11 mix or match \$ 8.50 ea.
12 and up ... mix or match \$ 8.25 ea.

C" BATTERY QUARTZ MOVEMENT

High Torque



High Torque "C" battery movement.
Comes with mounting hardware.

Hands & Batteries Not Included

QHTC380 3/8" dial 7/8" Shaft ... \$ 12.50 ea.
QHTC375 3/4" dial 1-1/8" Shaft \$ 12.50 ea.
6 to 11 \$ 12.25 ea.
12 or more \$ 12.00 ea.

**"C" High Torque
Continuous Sweep**



**Movement Size 2-1/8" W X 2-3/4" H
Hand Shaft is 7/8" over all**

Comes with mounting hardware.

Hands & Battery Not Included

74.142 ...3/8" Dial 7/8" Shaft ... \$ 19.50
6 or more \$ 19.25

C" BATTERY QUARTZ MOVEMENT



**HANDS & MOUNTING HARDWARE
INCLUDED. Batteries Not Included**

Dial Thickness - Shaft	PRICE
QMC 1/4" 5/8" 1 TO 5	\$ 9.50
QMC 9/16" 1" 6 TO 11	\$ 9.25
QMC 13/16" 1-1/4" 12 TO 24	\$ 9.00
25 And Up	\$ 8.75

QUARTZ MOVEMENT

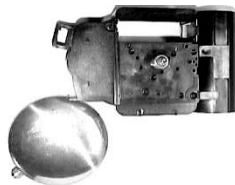

Westminster Chime Quartz Movement.
Rod & Bob Included. Mounting Hardware
Included **Batteries Not Included**

HANDS NOT INCLUDED

WESTMINSTER WITH PENDULUM

Dial Thickness --- 3/8,5/8 & 3/4
QWCP 3/8 ... 3/4" shaft \$ 29.75 EA
QWCP 5/8 ... 1" shaft \$ 29.75 EA
QWCP 3/4 1-1/4" shaft \$ 29.75 EA

WESTMINSTER NO PENDULUM



Requires one "C" Battery, Mounting
Hardware Included. **HANDS NOT
INCLUDED. Batteries Not Included**

Dial Thickness --- 3/8 & 3/4
QWC 3/8 ... 3/4" shaft \$ 27.50 EA
QWC 5/8 ... 1" shaft \$ 27.50 EA

"C" High Torque



"C" Battery High Torque Time Only
With out Pendulum.

Mounting Hardware Included

Hand & Battery Not Included

15.212 ... 3/8" dial 7/8" Shaft ... \$ 23.75 ea.
Movement With 22" Pendulum Rod
with 3-1/2" Bob.
15.211 \$ 28.75 ea.

AA Time only With Pendulum



Time only movement is
2-1/4" W X 4-3/4" H X 7/8" D

Take one AA battery
Rod & Bob Included.

(Battery not included)

Comes with mounting hardware. **Hands
Not Included.**

Dial Thickness 3/8" and 13/16"
15.084 ... 3/8" dial ... 3/4" shaft
15.085 ... 3/4" dial ... 1-1/4" shaft
\$ 10.75 ea. 6 and up \$ 10.50 ea.



**"C" BATTERY TIME ONLY WITH
Rod & Bob Included. Mounting Hardware
Included. Hands & Batteries Not Included**

Dial Thickness 3/8",5/8" & 3/4"
QMTP 3/8 ... 3/4" shaft \$ 16.25 EA
QMTP 5/8 ... 1" shaft \$ 16.25 EA
QMTP 3/4 ... 1-1/4" shaft ... \$ 16.25 EA

Prices Subject To Change Without Notice.

QUARTZ FIT-UP 3-1/2"

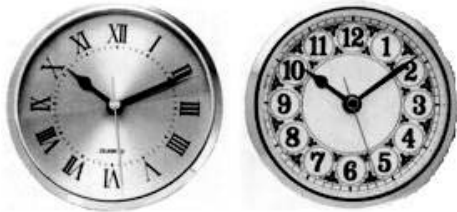

FITR 133 Gold Tone Roman
FITA 307 Old World German Arabic

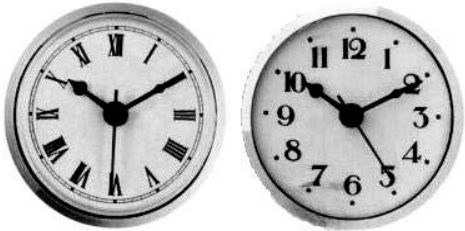

FITR 560 White Roman
FITA 559 Ivory Arabic
 Quarts fit-up 3-1/2" Dial.
 Mounting Diamenter 3"

Requires one AA battery. Batteries Not Included

- FITR 133Roman Numbers
- FITA 307 Arabic Numbers
- FITR 560 Roman Numbers
- FITA 559Arabic Numbers

\$ 10.50 ea.

6 and up mix or match ... \$ 10.25 ea.

Mini Fit-Up

2" Fit-Up with Gold Tone Bezels

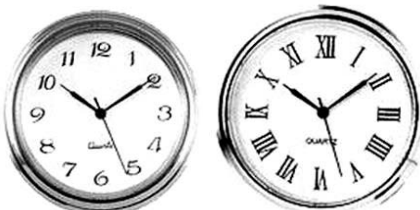

15.235 White Dial Arabic
 15.236 White Dial Roman



15.244 ... Cream Color Dial Arabic
 These 2" Fit-Up require a 1-3/4" mounting Hole. Mounting depth is 9/32" deep.
 Requires one # 377 watch battery.
 Battery Included with Each fit-up.

- 1 to 5 \$ 10.50 ea.
- 6 to 11 \$ 10.25 ea.
- 12 & up \$ 10.00 ea.

QUARTZ FIT-UP 3-7/8"

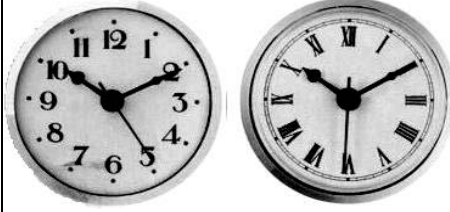

15.603 White Arabic
15.600 White Roman

Quartz Fit-up 3-7/8" Dial.
 Mounting Diamenter 2-5/16"
 Requires one "N" battery Not Included
 15.600 Roman Numbers
 15.603 Arabic Numbers
 \$ 11.00 ea. ... 6 or more \$ 10.75 ea.

QUARTZ FIT-UP 6-1/4"



15.343 15.342 15.344
 Quartz fit-up 6-1/4" Dial. Mounting Diamenter 3-1/4" Gold Bezel
 Requires one "AA" Battery Not Included
 15.343 ... Gold dial with Roman Numbers
 15.342 ... White dial with Arabic Numbers
 15.344 ... Fancy dial with Arabic Numbers
 \$ 24.75 ea. 6 and up \$ 24.50 ea.

QUARTZ FIT-UP 2-3/4"



FITA 586 White Arabic
FITR 592 White Roman



FITA 597 Fancy Arabic Ivory
 2-3/8" Mounting Hole

This fit-up is with Arabic numbers
 These movements are fast, easy installation .. and only 5/8" thick for mounting. Spring clip mounting system.
 2-3/4" Fitup in Arabic And Roman
 Takes one "N" Battery Not Included.
 FITA 586 Arabic dial white
 FITR 592 Roman dial white
 FITA 597 Arabic Fancy dial
 \$ 10.75 ea.
 6 and up mix or match \$ 10.50 ea.

Mini Fit – up

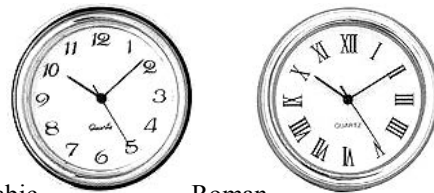

Arabic 15.278 ... White Dial
 Roman 15.276 ... White Dial
 15.279 ... Gold Dial 15.277 ... Gold Dial
 Bezel have scratch resistant miner glass lens.
 These mini fit-up. Has 1-7/16" outside diameter of bezel. Mounting hole 1-3/8" X 3/8" deep.
 Bezel are Gold Tone
 Comes complete with Battery.
 This movent requires a # 377 watch Battery.
 1 to 5 \$ 9.25 ea.
 6 to 11 ... \$ 9.00 ea. 12 and up ... \$ 8.75 ea.

Set and Forget Quartz Movement



AA Auto- Set quartz movement changes With Daylight savings.
 Comes in 1 shaft lengths 11/16" Over All Length. Shaft diameter 5/16"
 Size 2-7/32"W X 2-7/32"H X 5/8"D
 Mounting Hardware Included

Batteries Not Included
HANDS NOT INCLUDED
 15.450 11/16" shaft \$ 12.00 ea.
 6 to 11 \$ 11.75 ea.
 12 or more \$ 11.50 ea.

Round Mini Quartz Movement

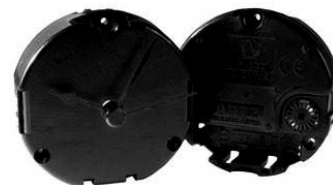

"N" Battery. Movement is 1-3/4" Dia.
 Hands Included.
 15.452 ... Movement Less Battery... \$ 5.00ea.
 15.453 ... Movement W/Battery \$ 6.50ea.

Quartz Movement Installation

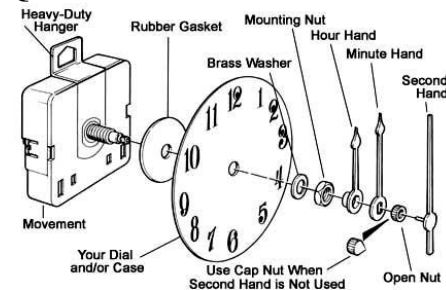

Prices Subject To Change Without Notice

DUMMEY WINDING ARBORS



07.380 .. 3/8" high 07.500 .. 1/2" high
07.100 ... 1" high
Packaged 2 of a size to a package
\$ 2.75 pkg. or 6 pkg. for \$ 2.50 pkg.

Rubber Washers



1/8" Thick Rubber washer for spacing quartz movement back in the case. Washers are 2" OD with 3/8" ID hole. 12 Washers per package.
74.121 \$ 3.00 pkg.

Adhesive Mounting Pad

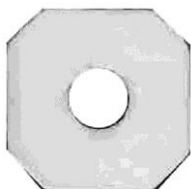

This double sided Adhesive mounting pad Is used for mounting quartz movements to dials and clock cases. Don't work well with the shortest shaft movements. The pad is 1-7/8" Square with center knock out hole.
15.160 \$ 1.00 ea.
6 or more \$ 0.85 ea.

AA or C Cell Battery Converter



You can convert any movement or things That take AA or C Battery into 110Volt DC. The converter will provide an Uninterrupted power supply,so in the event Of a power outage the battery will operate For up to 3 weeks. Comes with 6 ft cord.
15.624 AA Battery \$ 10.50 ea.
6 or more \$ 9.50 ea.
15.625 C Battery \$ 12.00 ea.
6 or more \$ 10.50 ea.

ELECTRIC CORDS



EC600 6' Brown Cord
EC601 6' White Cord
\$ 3.00 ea
6 to 11 \$ 2.75 ea. ... 12& up \$ 2.50 ea.

"S" ROTOR



Replaces: M2492, M3072, M3083, M3141, M3154 M3156, M3162, M3296, M3313, M3331, M3333 M3378 M3394, M3404, M3476, M3479, M3481 M3518, M3520, M3522, M3524, M3533, M3633 M3635, M3637, M3641
SR3520 \$ 15.00 ea.

Electric 2-1/4" X 2-1/4" Mini Movements.



Compact electric movement the same size As our AA Quartz movements. 2-1/4" square. 5/16" Threaded mounting shaft. This movement uses the standard I Stack hands. **Hands not included.** 110 Volt/UL Listed 6' Brown Cord. Each movement comes complete with mounting hardware.

Part no.	Shaft Length	Price
EM 316	9/16" 1 to 5	\$ 9.00ea.
EM 500	15/16" 6 to 11	\$ 8.75ea.
EM 750	1-3/16" 12 & up	\$ 8.50ea.

SYNCHRON MOTOR



Hansen A43RA motor 1RPM 60 cycle. With a 10 tooth pinion. 2" diameter, and 1-3/8 deep
SM43 \$ 33.75

JEFFERSON GOLDEN HOUR MOTOR



Jefferson Golden Hour 1/6 RPM (R) 27 Tooth gear. GH800 \$ 45.75

Telechron "H" Field & Coil Assembly

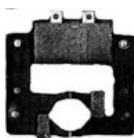

HFC3632 \$ 15.00 ea.

Prices Subject To Change Without Notice.

"H" Type Rotor



M3632 60 cycle and 3.6 RPM
Replaces: M519, M714, M768, M1145, M1313, M1630 M1678, M2023, M2052, M2146, M2275, M2309 M2317, M2319, M2322, M2394, M2396, M2398 M2475, M2676, M2682, M3025, M3097, M3136 M3150, M3151, M3230, M3401, M3434, M3420 M3424, M3497, M3499, M3614, M3617
HR3632 \$ 45.00 ea.
"H" Rotor and "H" Field & Coil Assembly. HFA3632 \$ 57.00 complete

SIMPLEX MOTOR

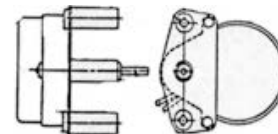

This motor will also replace some "B" Rotor applications. One RPM 60 cycles
SM 120 is Right Hand rotation
SM120 \$ 45.50 ea.
3 or more \$ 45.25 ea.

Quartz Trigger Replacement Movements

For Trains, Birds, Cuckoo, and Many More
Movement Size 2-1/8 X 2-1/8 X 5/8
Requires 1 AA Battery Not Included



Hand shaft for 15.454 is 7/8" Long
The Hand Shaft on this Movement takes I Stack Hands.
15.454 \$ 13.25 ea.
6 or More \$ 13.00 ea.

Quartz Trigger Replacement Movements

For Trains, Birds, Cuckoo, and Many More
Movement Size 2-1/8 X 2-1/8 X 9/16
Requires 1 AA Battery Not Included



Hour Post Diameter 5.55 mm (0.218")
Minute Post Diameter 3.66 mm (0.144")
The Hand Shaft on this Movements is for Push On Hands.
Hand Shaft for 15.455 is 9/16"
Hand Shaft for 15.456 is 7/8"
15.455 \$ 9.50 ea.
15.456 \$ 9.50 ea.
6 or More \$ 9.00

Clock Hands...

Dial Sizes - 2-3/4" to 10" .. \$.75 pr. . 6 pr. or more \$.65 pr.
 Dial Sizes - 11" to 13" .. \$ 2.50 pr. 6 pr. or more \$ 2.25 pr.
 Price Subject To change Without Notice

To select correct length hands, measure from movement shaft hole to time ring (numerals) on your dial.

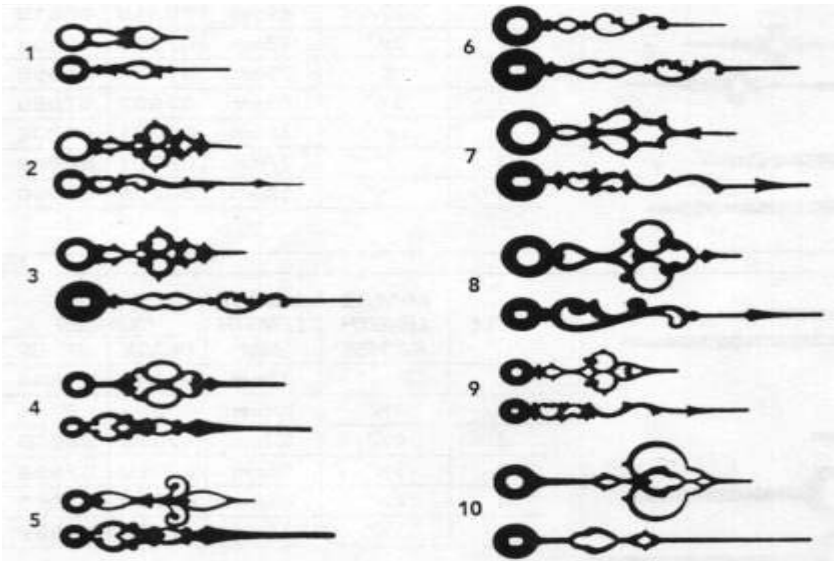

Quartz Serpentine I Shaft Hands

STYLE	MINUTE LENGTH INCHES	MINUTE LENGTH MM	STOCK NUMBER	
			BLACK	BRASS
1	1-3/8"	35mm	BH683	GH684
2	1-3/8"	35mm	BH690	GH691
2	2-1/16"	52mm	BH652	GH655
3	2-3/8"	61mm	BH653	GH656
4	3-3/8"	86mm	BH602	GH604
5	3-3/8"	86mm	BH601	GH603
6	2-3/8"	61mm	BH654	GH657
7	2-1/2"	63mm	BH632	GH633
8	3-1/8"	79mm	BH630	GH631
9	3-1/8"	79mm	BH731	GH718
9	4-1/8"	104mm	BH614	GH615
10	3-1/8"	79mm	BH673	GH674

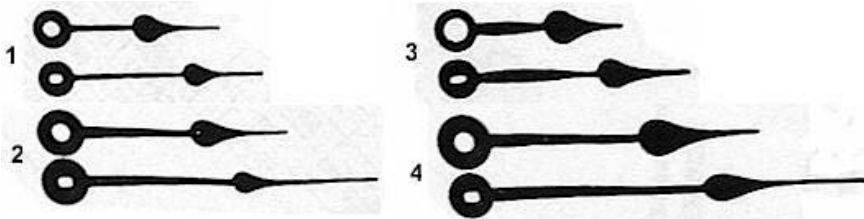

Quartz Spade I Shaft Hands

STYLE	MINUTE LENGTH INCHES	MINUTE LENGTH MM	STOCK NUMBER	
			BLACK	BRASS
1	2-7/8"	74MM	BH798	GH799
2	1-7/8"	47mm	BH692	GH693
2	2-1/2"	63mm	BH636	GH637
2	2-3/4"	69mm	BH695	GH696
2	3-7/16"	87mm	BH627	GH628
2	4"	101mm	BH671	GH672
2	4-1/2"	115mm	BH625	GH626
2	7"	178mm	BH681	
3	2-1/4"	54mm	BH650	GH651
3	5-1/2"	138mm	BH712	
4	5-1/4"	133mm	BH801	

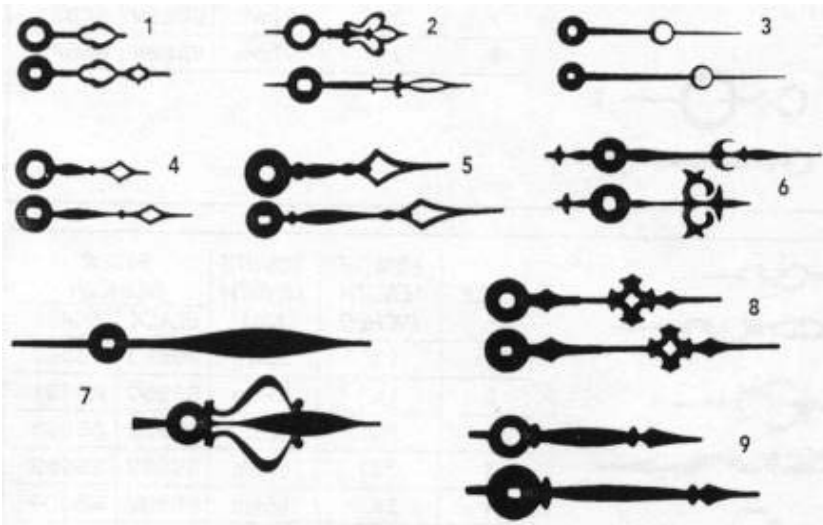

Quartz Fancy I Shaft Hands

STYLE	MINUTE LENGTH INCHES	MINUTE LENGTH MM	STOCK NUMBER	
			BLACK	BRASS
1	1-3/4"	45mm	BH803	GH804
2	1-3/4"	45mm	BH715	GH805
3	4-1/2"	115mm	BH667	GH668
4	1-3/8"	35mm	BH679	GH680
5	2-3/4"	69mm	BH618	GH619
5	3-5/16"	140mm	BH553	GH556
6	3"	75mm		GH658
7	3-1/4"	82mm	BH787	
8	2"	52mm	BH701	GH702
8	3"	77mm	BH621	GH620
9	2-1/4"	58mm	BH639	GH940

SWORD I SHAFT HANDS

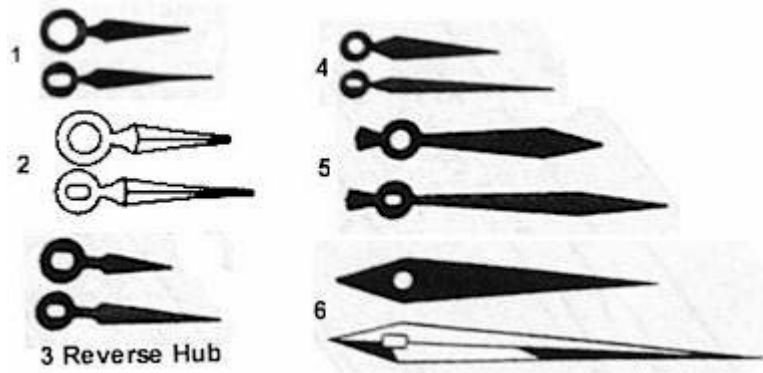

Dial Sizes - 2-3/4" to 10" .. \$.75 pr.
 6 pr. or more \$.65 pr.
 Dial Sizes - 11" to 13" .. \$ 2.50
 pr. 6 pr. or more \$ 2.25 pr.

STYLE	MINUTE LENGTH INCHES	MINUTE LENGTH MM	STOCK NUMBER	
			BLACK	BRASS
1	1-7/8"	48mm	BH716	GH726
2	1"	25 mm	BH758	GH785
3	1-1/2"	38mm	BH732	GH739
4	2-1/4"	58mm	BH988	GH789
5	2-5/8"	68mm	BH612	GH613
5	3-5/8"	92mm	BH708	GH707
6	2-3/4"	69mm	BH774	GH775

CONTEMPORARY I SHAFT HANDS

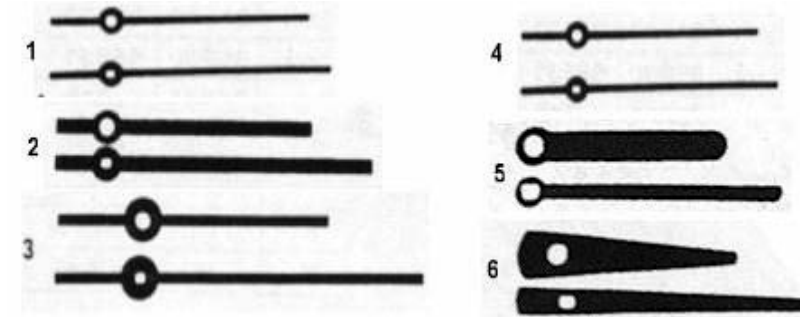

STYLE	MINUTE LENGTH INCHES	MINUTE LENGTH MM	STOCK NUMBER	
			BLACK	BRASS
1	2-13/16"	71mm	BH743	GH744
2	4-1/4"	108mm	BH709	GH710
3	3-3/4"	95mm	BH792	GH 793
4	4-1/4"	108mm	BH643	GH644
5	2-1/8"	53mm	BH780	GH783
6	2-1/8"	53mm	BH662	GH663

Quartz Push On Hands

Hand Style	Length of min. hand	Part No. Black	Part No. Gold
	2"	BH834	
	2-3/4"	BH836	
	1-3/8"	BH832	
	3"	BH165	

Quartz Second Hands

STYLE	LENGTH INCHES	LENGTH MM	COLOR
SH101	1-3/4"	45mm	Black
SH022	1-3/4"	45mm	Brass
SH018	1-3/8"	35mm	Black
SH019	1-3/8"	35mm	Brass
SH077	3"	77mm	Black
SH079	3"	77mm	Brass
SH029	3-1/2"	83mm	Black
SH031	3-1/2"	83mm	Brass
SH148	4"	101mm	Black
SH149	4"	101mm	Brass

EXTRA LARGE MOUNTING NUTS FOR AA MOVEMENTS



Extra Large Hex Nut for mounting the AA quartz movement to dial with larger Than 5/16" hole. The nut and washer are 1/2" outside diameter. Comes with 1 nut & 1 washer. Each Package 3 nuts & 3 washers
 74.120 \$ 2.00 pkg.
 3 or more pkg. \$ 1.75 pkg.

NUMERALS FOR CLOCKS
Plastic

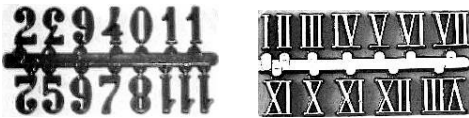

Arabic No. Roman No.
BLACK OR GOLD
 SIZES 3/8", 1/2", 5/8", 3/4", 1"
 NUMBER SIZE --- ARABIC
 BLACK ---- GOLD
 3/8" N/A GA057
 1/2" BA006 GA048
 5/8" BA017 GA059
 3/4" BA012 GA054
 1" BA003 GA045
 NUMBER SIZE --- ROMAN
 BLACK ---- GOLD
 1/2" N/A GR071
 5/8" N/A GR081
 SIZES 3/8" TO 1"
 1 TO 5 SETS \$ 1.25
 6 TO 11 SETS \$ 1.10
 12 AND UP \$ 1.00

"N" Batteries



"N" Batteries for Quartz fit up
 74.104 \$ 2.00 ea.
 6 to 9 \$ 1.95 ea.
 10 to 24 \$ 1.85 ea.
 25 & up \$ 1.75 ea.
377 Watch Battery for Fit-Up
 74.105 \$ 2.50 ea.
 6 to 9 \$ 2.45 ea.
 10 & up \$ 2.35 ea.

Quartz High Torque I Shaft Handes
Hands are Black

74.797	12" Long Min Hand	\$ 6.50
74.390	14-3/8" Long Min Hand	\$ 9.75

Prices Subject To Change Without Notice.

**Mechanical Movements
SPADE HAND**



- 74.150 4" DIAL SQUARE
- 74.160 4" DIAL OBLONG
- 74.145 4-1/2" DIAL .. SQUARE
- 74.245 4-1/2" DIAL .. OBLONG
- 74.151 5" DIAL SQUARE
- 74.161 5" DIAL OBLONG

\$ 2.25 PR. ... 3 PR. & UP \$ 2.00 PR.

- 74.152 6" DIAL SQUARE
- 74.162 6" DIAL OBLONG

\$ 2.75 PR.

- 74.153 7" DIAL SQUARE
- 74.163 7" DIAL OBLONG
- 74.164 9" DIAL SQUARE

\$ 3.00 PR. ... 3 PR. & UP \$ 2.75 PR.

MALTESE HANDS



This is DIAL sizes for hand size.

- 74.1604 4" DIAL SQUARE
- 74.1704 4" DIAL OBLONG
- 74.1605 5" DIAL SQUARE
- 74.1705 5" DIAL OBLONG

\$ 2.25 PR. ... 3PR. & UP \$ 2.00 PR.

- 74.1606 6" DIAL SQUARE
- 74.1706 6" DIAL OBLONG

\$ 2.75 PR.

- 74.1607 7" DIAL SQUARE
- 74.1707 7" DIAL OBLONG

\$ 3.00 PR. ... 3 PR. & UP \$ 2.75 PR.

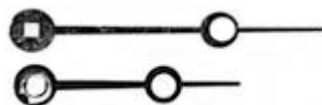

MOON HANDS

- 74.005 5" SQUARE HOLE
- 74.006 5" OBLONG HOLE

\$ 3.00 PR. ... 3 PR. & UP \$ 2.75 PR.

Fleur De Lys Hands

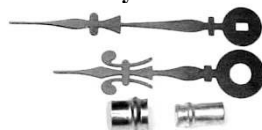

The minute hand has a oblong hole and Hour hand has two bushing, of which one Must be installed in hour hand.

- 74.170 4" Dial \$ 4.00 ea.
- 74.171 4-1/2" Dial \$ 4.25 ea.
- 74.172 5" Dial \$ 4.50 ea.

Prices Subject To Change Without Notice

O G Hands

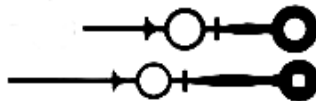

- 74.007 ... SQ Hole 7" Dial ... \$ 3.00 pr.

Seth Thomas Style Hands

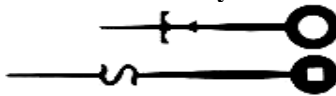

- 74.154 ... 3-1/2" Dial Sq Hole ... \$ 3.00 pr.
- 74.155 ... 5" Dial Sq Hole \$ 3.00 pr.

Spade Hands w/Hole 5" dial



- 74.156 ... Square Hole \$ 2.00 pr.
- 74.157 ... Oblong Hole \$ 2.00 pr.

Vienna Regulator Hands

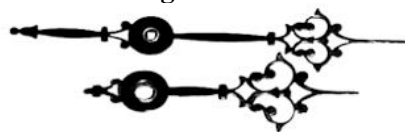

Both hands have Brass Bushing in them. Made of Black Metal.

- 74.158 5" Dial \$ 8.50 pr.
- 74.159 7" Dial \$ 15.00 pr.

Spade French Hands

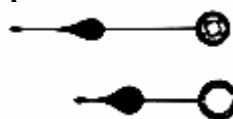

Hand are of Blue steel. Brass bushing in both hands. Length is of the minute hand center hole to tip.

- 74.181 1-1/8" \$ 12.00 pr
- 74.182 1-9/16 \$ 12.00 pr
- 74.183 2" \$ 12.00 pr.
- 74.184 2-3/8" \$ 12.00 pr.

Trefoil French Hands

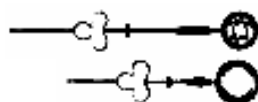

Hand are of Blue steel. Brass bushing in both hands. Length is of the minute hand center hole to tip.

- 74.186..... 1-1/8" \$ 12.00 pr.
- 74.187..... 1-9/16" \$ 12.00 pr.
- 74.188..... 2" \$ 12.00 pr.
- 74.189..... 2-3/8" \$ 12.00 pr.

Seth Thomas # 2 Second Hand

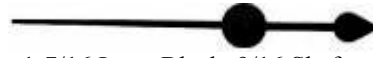

- 1-7/16 Long Black 9/16 Shaft
- 74.236 \$ 3.00

Breguet French Hands

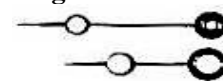

Hand are of Blue steel. Brass bushing in both hands. Length is of the minute hand center hole to tip.

- 74.190..... 1-1/8" \$ 12.00 pr.
- 74.191..... 1-9/16" \$ 12.00 pr.
- 74.192..... 2" \$ 12.00 pr.
- 74.193..... 2-3/8" \$ 12.00 pr.

**GERMAN CLOCK HANDS
SERPENTINE**



The minute hand has a brass bushing in it That is friction fit. The hand are Black.

- GH005 5" DIAL \$ 7.25 PR.
- GH006 6" DIAL \$ 7.25 PR.
- GH007 7" DIAL \$ 7.25 PR.
- GH008 8" DIAL \$ 7.25 PR.
- GH010 10" DIAL ... \$ 7.50 PR.

Half Spade Hands



Blue Steel Hands with Square and Oblong Hole. For Mechanical Movements.

- | | Dial | Hole | |
|-------------------|--------|------|-------------|
| 74.173 ... 4" | Square | ... | \$ 2.75 pr. |
| 74.174 ... 4" | Oblong | ... | \$ 2.75 pr. |
| 74.175 ... 4-1/2" | Square | ... | \$ 2.75 pr. |
| 74.176 ... 5" | Square | ... | \$ 2.75 pr. |
| 74.177 ... 5" | Oblong | ... | \$ 2.75 pr. |
| 74.178 ... 6" | Square | ... | \$ 2.75 pr. |
| 74.179 ... 6" | Oblong | ... | \$ 2.75 pr. |
| 74.180 ... 7" | Oblong | ... | \$ 2.75 pr. |

Calendar Hands

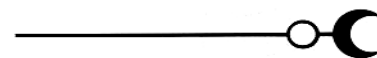

Calendar hands with Brass bushing in center. Hand are measured from center of bushing to end. Black in Color.

- 74.041 3" \$ 3.00 ea.
- 74.042 4-1/2" \$ 3.25 ea.
- 74.043 5-3/4" \$ 4.00 ea.

Gallery Clock Hands



Hands come unfinished steel .038 with min & hour hand bushing

- 74.270 ... 6-1/8" min Hand ... \$ 11.00
- 74.272 ... 8-1/4" min Hand ... \$ 14.50



Second Hand

- 3/4" Black for 1-1/2" Min Dial
- 74.233 ... 1/2" Shaft \$ 3.00 ea.
- 74.234 ... 1-1/8" Shaft \$ 3.00 ea.
- 74.235 ... 1-1/2" Shaft \$ 3.50 ea.

Hand Bushing Adjusting Tool



Plastic handle with Square End steel shaft for adjusting Friction bushing in minute hands.

7-1/2" overall length. **German Made**
74.500 \$ 8.25 ea.



Hand Nut For Hermle & German Clocks
Assortment of German hand nuts for
Wall, Mantle, and Floor clocks.

74012 ...6 Wall & mantle ... \$ 3.25 pkg.
74015 ...6 Floor \$ 4.25 pkg.
74013 has 8 wall & mantle, 4 floor
74013 ... Total of 12 pc. \$ 6.75 pkg..

Swiss Style Hand Washers

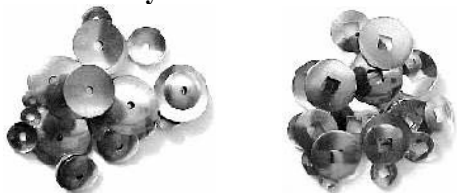

Round Hole

Square Hole

Swiss Style hand washers Brass and Blued
Steel. They work good on French and
English movements. 25 pc. To a Package.
74.030 .. Brass Round hole ... \$ 7.75 pkg.
74.031 .. Brass Square hole \$ 7.75 pkg.
74.032 .. Steel Round hole \$ 7.75 pkg.
74.033 .. Steel Square hole ... \$ 7.75 pkg.

CLOCK HAND WASHERS



20 pc. Per package.
74025 - - Brass RD. hole \$ 2.00 pkg.
74026S - Brass SQ. hole small - \$ 2.00 pkg.
74026L - Brass SQ. hole large - \$ 2.00 Pkg.
74027 - - Steel RD hole \$ 2.00 pkg.
74027S - Steel SQ. hole small - \$ 2.00 pkg.
74027L - Steel SQ. hole large - \$ 2.00 pkg.

ASSORTMENT OF HAND WASHERS
30 pc. Per package.
10pc. RD hole, 10pc. SQ hole small
10 pc. SQ hole large Brass.
74020 \$ 3.00 pkg.
10pc. RD hole, 10pc. SQ hole small
10 pc. SQ hole large Steel
74021 \$ 3.00 pkg.

CLOCK HAND BUSHING



74.022 **74.028**
Hermle Brass Hr and Min hand bushing
Assortment. 12 pc. In a package.
74.022 \$ 8.50 pkg.
1 set French Hand Bushing
74.028 \$ 2.75 set.
Set of 74.022 and 74.028
74.029 \$ 11.00

ASSORTMENT OF HAND NUTS FOR SMALL CLOCKS

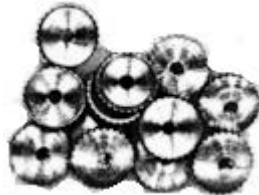

Assortment has 12 pc. In a pkg.
74014 \$ 3.50 pkg.

AMERICAN HAND NUT ASSORTMENT

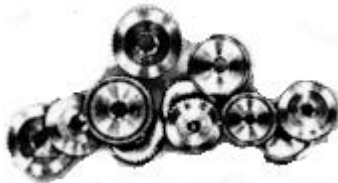

Assortment has 12 pc. 3 ea. Of 4 sizes
74010 \$ 5.50 pkg.

Brass Flat Washer for Tall Case Clock Made of Brass



74.023 ... Small ... \$ 1.50 ea.
74.024 ... Large ... \$ 1.50 ea.

Cuckoo Hand Washers



12 Cuckoo Hand washers per package
73.414 \$ 3.75 pkg.

Prices Subject To Change Without Notice.

Cuckoo Hand Nuts Assortment



Assortment of 12 pc. Cuckoo Hand Nuts
73.411 \$ 4.25 ea.

E-Clip Assortment



50 pieces assorted
72.208 \$ 6.50

Lock Washer For Regula



Lock washer used on Regula Cuckoo
Movements. 10 pc per Pkg.
72.214 \$ 1.50

Hermle E-Clips



72.209 72.210 72.211
3 Sizes of E-Clips from Hermle. 20 pc.
To a pkg. \$ 1.50 pkg.
Also in assortment of 60 pc. 20 pc of
Each size.
72.212 \$ 4.50 pkg.

E-Clip Assortment



Made in India
E-Clip assortment 144 pieces.
72.207 \$ 4.50

Brass Flat Washer Assortment



74.495 ... 144 piece ... \$ 5.00

Keystone Lathe Steady Rest

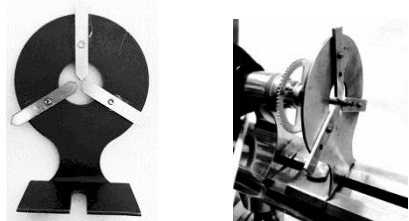

12.326 Watchmakers Steady Rest Mounting Bolt Included (Lathe not Included)

Steady rest for watchmakers lathe.
12.326 \$ 48.00

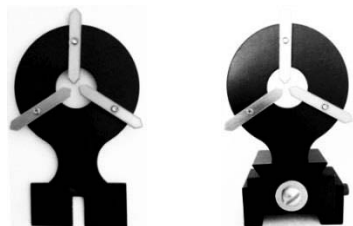

12.327 Sherline Steady Rest Mounting Bolt Included (Base not Included)

Steady rest for Sherline lathe.
12.327 \$ 48.00

Alarm Mechanism

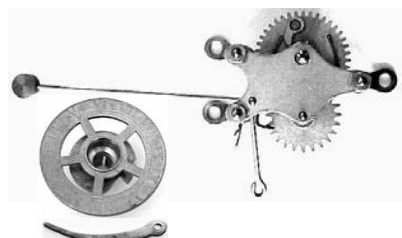

Alarm mechanism with center alarm ring
And actuating arm. For Kitchen Clock and
Etc. Comes with mechanism and hammer.
24.809 \$ 20.00 ea.



Center Alarm ring Alarm Actuator Lever
24.814 24.815
24.814 ... Center Alarm Ring..... \$ 4.25
24.815 ... Alarm Actuator Lever... \$ 3.50

Brass Pinion for Gilbert



Top Side

Under Side

Replacement brass drive pinion for Gilbert
mantle clocks movements. Pinion is .50"
diameter with a .158 undersize center hole
for a precision fitting. 12 teeth.
85.009 \$ 12.75 ea.

Fast Slow Regulator



Reproduction Fast Slow Regulator device
for Session Mantle clock. It includes
regulation block and key shaft. This
regulator can possibly be adapted to fit
other Clocks.

85.100 \$ 10.00 ea.
3 or more \$ 9.75 ea.

Calendar Fit-ups



Calendar conversion movement to fit
calendar clocks.

79.450 ... Universal..... \$ 11.25 ea.
79.451 ... Ansonia \$ 11.25 ea.
79.452 ... Seth Thomas ... \$ 11.25 ea.
79.453 ... Waterbury \$ 11.25 ea.

Session Calendar Fit-Ups



79.454 \$ 11.25 ea.

Tall Case Calendar Drive Gear



Calendar drive and trip wheel with pin.
Wheel with pin is 48 mm diameter.
79.455 \$ 14.50

Universal Governor (Fans)

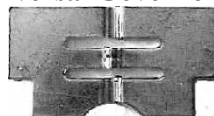

Made of Brass

79.070 \$ 1.00

Governor (Fans) Assortment

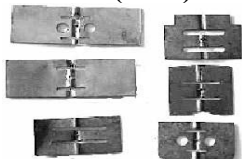

Set of 6 sizes made of Brass
79.071 \$ 6.25

Prices Subject To Change Without Notice.

-30-

Lathe Pivot Polishing Set of 10 Arbors

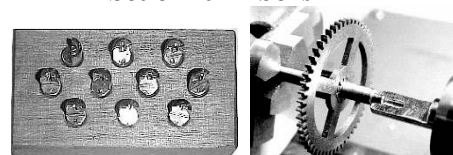

This set of Lathe Pivot Polishing Arbors
Comes in a wood block.

87.605 \$ 48.50 set.

Manual Pivot Polishing Tool

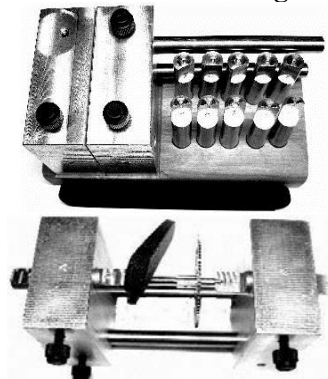

Polish pivots when you don't have
all the lathes to polish pivots. By
using the bar with a rubber edge
you can power the wheel while
you use a buff stick or other
polishing tools.

There is 10 double ended arbors
with the tool.

87.600 \$ 120.00



Pivot polishing stick to put your favorite
Polishing paper on. Stick is 1/4" wide
By 5-1/2" long. 12 pc to a package.
87.603 \$ 1.50 pkg.

LEVELS



Level for leveling Clocks and etc.
The bubbled level measured 1-1/2" long.
24.700 \$ 2.00 ea.
12 to 23 \$ 1.75 ea.
24 and up \$ 1.50 ea.

Wobble Wedges

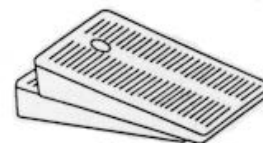

WW112 PKG OF 6 \$ 2.50
WW1100 ... PKG OF 100 ... \$ 28.00

Movement Test Stand



Hold clock movements when regulating and making adjustments. Grooved brackets are adjustable up to 11". 3 leveling screws are in the base. Post diameter 1/2".

24.800 \$ 50.00 each

Movement Test Stand

Aluminum test stand Completely adjustable. It has three thumb turns For leveling in all direction The horizontal arms are grooved to hold movements. The round collars are designed to hold round movements. The rugged aluminum stand. The stand is 16-1/2" tall with a 1/2" post diameter.

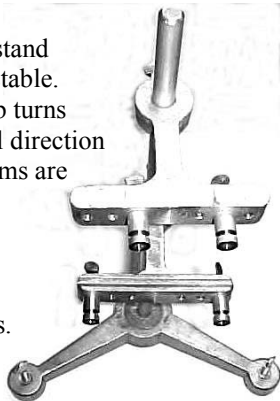

24.801 \$ 57.00 ea.

Test Stand Accessories



Clamp 5/8" Aluminum
24.897 \$ 12.50 ea.



Test Stand Movement Holder Aluminum
24.899 \$ 12.50 ea.

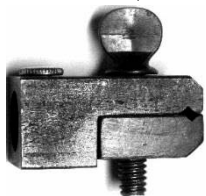

Test Stand Top Clamp
24.896 \$ 13.50 ea

Test Stand Accessories



Test Stand Brackets For Round Movements

24.898 \$ 12.50 ea

Aluminum Test Stand Bracket

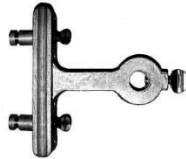

6 pieces to the Aluminum Bracket
24.895 \$ 14.50 ea.

MOVEMENT HOLDER



Movement holder can be used to assemble movements and then hang on a board or the wall for testing. Included in the set is 4 post 1 Strap Bracket And a wall stud for the holder to hang on.

28.802 \$ 20.50

Long Movement Assembly Post



Assembly Post 3 3/4" long. 1 post or Set of 4

28.805 ... 1 Post \$ 7.50 each
28.806 ... Set of 4 pc. ... \$ 28.75 set

Two In One Clock Plate Spreader



This plate spreader is two tools in one. You can use it to check pivots and arbors of clocks, also to spread clock plates to adjust wheel.

43.876 \$ 25.00 ea.

Prices Subject To Change Without Notice.

French Movement Test Stand

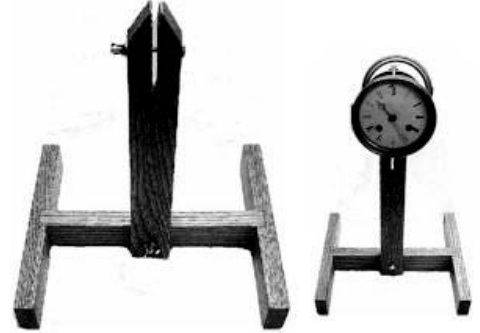

24.805 \$ 45.00

Movement Holders

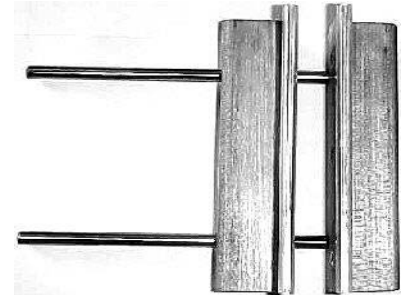

Adjustable movement stand. Comes in two Sizes for holding Mantle clocks and also Grandfather movements.

Small movement holder

6" wide 2-3/4" high opens to 4-1/2" in side

Large movement holder

7-1/2" wide 3-14" high opens to 7" in side

24.802 Small \$ 35.00

24.803 Large \$ 40.00

Cuckoo Lift Wire



76.188 2-1/8" Long ... \$ 0.75 ea.
76.189 2-1/2" Long ... \$ 0.75 ea.
76.190 2-3/4" Long ... \$ 0.75 ea.
76.191 3-1/4" Long ... \$ 0.75 ea.
76.192 4" Long \$ 0.75 ea.
76.193 4-1/4" Long ... \$ 0.75 ea.
76.194 4-1/2" Long ... \$ 0.75 ea.
76.195 6-1/4" Long ... \$ 0.75 ea.

Lift wire assortment

2 ea. Of 8 sizes 16 pc.

76.187 \$ 9.50

Cuckoo Pendulum Hangers



76.196 ... 3-1/8" long ... \$ 1.00 ea.
76.197 ... 3-1/2" long ... \$ 1.00 ea.
76.198 ... 4" long \$ 1.00 ea.
76.199 ... 4-1/4" long ... \$ 1.00. ea.
76.200 ... 4-3/4" long ... \$ 1.00 ea

We accept these Credit Card Unless other arrangement are Made.



CUCKOO MOVEMENT



REGULA 25 1 DAY

24.825 ...19.5cm PL ... \$ 64.75 ea.
 24.826 ...23.5cm PL ... \$ 64.75 ea.
 3 or more \$ 64.25 ea.

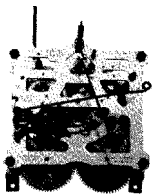

REGULA 34 8 DAY

24.834 \$ 104.50 ea.
 3 or more \$ 104.00 ea.



BELLOW TOPS ONLY

BT 100 ... 1 1/8 X 1 1/2 ... \$ 7.00 PR
 BT 200 ... 1 1/8 X 1 3/4 ... \$ 7.00 PR
 BT 300 ... 1 1/4 X 1 3/4 ... \$ 7.00 PR
 BT 400 ... 1 1/4 X 2 \$ 7.50 PR
 BT 500 ... 1 1/4 X 2 1/4 ... \$ 7.50 PR
 BT 600 ... 1 1/2 X 2 3/8 ... \$ 8.50 PR

Trapezoidal Cuckoo Bellow Top



Antique style tapered bellow tops
 2-1/4" long X 2" wide taper to 1"
 Sold in pairs.

BT700 \$ 17.00 set.

Cuckoo Horn and Mouth Piece



Brown color

76.209 ...28 mm (1-1/8")..... \$ 6.25 ea.
 76.210 ...35 mm (1-3/8")..... \$ 6.50 ea.
 76.211 ...42 mm (1-5/8")..... \$ 6.75 ea.
 76.212 ...55 mm (2-3/16")... \$ 8.00 ea.

Cuckoo Clock

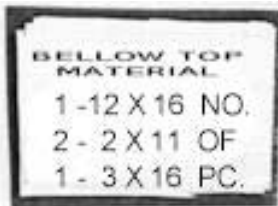

Bellow Top Material

WILL DO BETWEEN 10 & 14 TOP
 BTM 1216 \$ 7.25 PK



SQ. Hole



Takes Bushing

Cuckoo Hands White

W/BUSHING	SIZE	PRICE
74.058 ...	20 mm Hands	\$ 1.50 PR
74.060	22 MM	\$ 1.75 PR
74.061	28 MM	\$ 1.75 PR
74.062	33 MM	\$ 1.75 PR
74.063	36 MM	\$ 2.00 PR
74.064	42 MM	\$ 2.00 PR
74.065	49 MM	\$ 2.25 PR
74.066	58 MM	\$ 2.25 PR

Cuckoo Hands Ivory

74.461	28 MM	\$ 1.75 PR
74.462	33 MM	\$ 1.75 PR
74.463	36 MM	\$ 2.00 PR
74.464	42 MM	\$ 2.00 PR
SQUARE HOLE		
	SIZE	PRICE
74.080	SQ... 22 MM	\$ 1.50 PR
74.081	SQ... 28 MM	\$ 1.50 PR
74.082	SQ... 33 MM	\$ 1.50 PR
74.083	SQ... 36 MM	\$ 1.50 PR
74.084	SQ... 42 MM	\$ 1.50 PR
74.095	SQ... 49 MM	\$ 2.00 PR
74.096	SQ... 58 MM	\$ 2.00 PR

CUCKOO WEIGHT



PART NO	GRAMS	LBS	PRICE
CM79201	275	5/8	\$ 4.00 ea.
CM79202	320	3/4	\$ 4.00 ea.
CM79203	375	7/8	\$ 4.50 ea.
CM79204	420	1	\$ 4.50 ea.
CM79205	500	1-1/4	\$ 6.75 ea.
CM79207	750	1-3/4	\$ 10.25 ea.
CM79209	1000	2-1/4	\$ 11.00 ea.
CM79210	1260	2 3/4	\$ 12.00 ea.
CM79212	1500	3 1/4	\$ 12.50 ea.
CM79213	1750	4	\$ 15.50 ea.

Prices Subject To Change Without Notice



CUCKOO NO. SET

PART NO	SIZE	PRICE PER SET
CM73401	9 MM	\$ 1.25
CM73402	11 MM	\$ 1.25
CM73403	12 MM	\$ 1.50
CM73404	14 MM	\$ 1.75
CM73405	16 MM	\$ 2.00
CM73406	20 MM	\$ 2.25
CM73407	24 MM	\$ 2.50



BIRD W/FIXED WING - METAL BASE
 CB22 \$ 2.00



FAN ASSEMBLY

The newer style governor may require
 The hole to be filed to fit old music box.

MBGS ... Brass ... for 18 notes Small.

MBGS 18 \$ 30.75 ea.

MBGL 22/12 ... Brass 22/28/36 notes
 12 tooth pinion Large.

MBGL 22/12..... \$ 18.75 ea.

MBGL 22/14 ... Brass 22/28/36 notes
 14 tooth pinion Large.

MBGL 22/14..... \$ 26.50 ea.

Music Box Governor for 22 notes
 13 tooth pinion

24.195 \$ 18.00 ea.

Cuckoo Clock Music Box

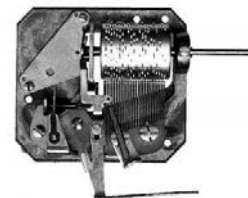

Two Tune Music Box. Swiss Made
 Edelweiss & Happy Wanderer
 24.222 \$ 66.75ea.

Cuckoo Lift Wire Assortment

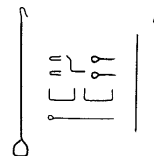

32 Pieces in the Assortment

LIFT WIRE SET

CLW100 \$ 6.00

Cuckoo Clock Pendulum



Small cuckoo pendulum maple leaf.
The wood pendulum stick W/ hook 7" long.
The maple leaf is 2" wide X 2-1/4" long.
76.201 Brown \$ 7.50 ea.
76.101 Green \$ 7.50 ea.
76.301 Blond \$ 7.50 ea.

Medium cuckoo pendulum maple leaf.
The wood pendulum stick W/ hook 7" long.
The maple leaf is 2-1/2" wide X 3" long.
76.202 Brown \$ 8.00 ea.
76.102 Green \$ 8.00 ea.
76.302 Blonde \$ 8.00 ea.

Large cuckoo pendulum maple leaf.
The wood pendulum stick W/ hook 7" long.
The maple leaf is 3" wide X 3-3/4" long.
76.213 Brown \$ 8.50 ea.
76.103 Green \$ 8.50 ea.
76.303 Blond \$ 8.50 ea.



1 day cuckoo pendulum oak leaf.
The wood pendulum stick W/ hook 7" long.
The oak leaf is 1-1/2" wide X 3-1/4" long.
76.203 Brown \$ 8.25 ea.

8 day cuckoo pendulum oak leaf.
The wood pendulum stick W/ hook 7" long.
The oak leaf is 1-3/4" wide X 3-7/8" long.
76.204 Brown \$ 9.25 ea.



1 Day Cuckoo Chalet pendulum. 7-1/4" long pendulum stick w/hook. 2" X 3" shield.
76.205 Brown \$ 7.75 ea.
8 Day Cuckoo Chalet pendulum. 7-1/4" long pendulum stick w/hook. 2-1/2" X 3-7/8" shield.
76.206 Brown \$ 10.50 ea.

Brown Cuckoo Pendulum Wood Rod



76.221 ... 3/8" W X 9-1/2" L ... \$ 1.50

Cuckoo Pendulum Hook



Cuckoo top for 3/8" wood pendulum stick.
76.222 \$ 0.75 ea.

Top "A" Frame With Bird



Tops for cuckoo clocks with a bird and Maple leaf. Measurement of tops are from End to end.
76.250 ... 6-3/4" Brown \$ 16.50 ea.
76.253 ... 8-1/4" Brown \$ 19.50 ea.
76.256 ... 9-1/2" Brown \$ 28.50 ea.
76.259 ... 10-1/2" Brown \$ 34.50 ea.

Cuckoo Antlers



Cuckoo Antlers are measured for size from tip of antler to center of mounting post.
76.223 2-1/2" \$ 4.75 ea.
76.224 3-1/2" \$ 5.50 ea.
76.225 4" \$ 7.00 ea.
76.226 4-1/2" \$ 8.75 ea.

Unfinished Deer Heads



Hand Carved
76.227 2-1/2" \$ 20.00 ea.
Antlers 76.223 fit this head
76.228 3-1/2" \$ 24.50 ea.
Antlers 76.224 fit this head
76.229 4-1/2" \$ 28.00 ea.
Antlers 76.225 & 76.226 fit this head

Cuckoo Roof Hook



Clip to hold Cuckoo "A" frame to roof of Cuckoo clock. 5/8" long X 3/8" wide.
2 pices per package.
76.260 \$ 1.25

Cuckoo Roof Clip



For mounting cuckoo top to case old style.
1 per package.
76.261 \$ 1.50 ea.

Cuckoo Hand Nut Assortment



Assortment of 12 pc. Cuckoo hand nuts.
3 each of four different sizes
73.411 \$ 4.50 pkg.

Cuckoo Dials (Wood)



Brown color with white Roman numbers
74.465 ... 2-1/4" Dia... 60 mm ... \$ 5.00 ea.
74.468 ... 3-1/8" Dia... 80 mm ... \$ 5.50 ea.
74.490 ... 3-1/2" Dia... 90 mm ... \$ 6.25 ea.
74.450 ... 4" Dia 100 mm ... \$ 7.25 ea.
74.410 ... 4-1/4" Dia... 110 mm .. \$ 7.75 ea.
74.420 ... 4-3/4" Dia. .. 120 mm .. \$10.75 ea.
74.430 ... 5-1/8" Dia. .. 130 mm .. \$13.50 ea.

Cuckoo Door



Cuckoo clock door wood Brown
74.475 .. 3/4" wide X 1" Tall \$ 1.25 ea.
74.476 .. 15/16" W X 1-3/8" H... \$ 1.50 ea.
74.477 .. 1-3/16" W X 1-5/8" H .. \$ 1.75 ea.

Prices Subject To Change Without Notice.

Paper Dials

Maker Paper Dials

Come in White & Ivory.
Ivory dial Have a off-white
Appearance. Measurement
Are across time track.

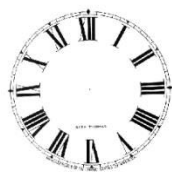

**Roman
Maker
Name**



**Arabic
Maker
Name**

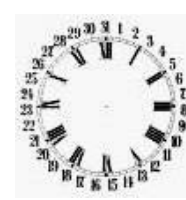

**Calander
Roman
Maker
Name**

Dial Maker Name	White	Ivory	White	Ivory	White	Ivory
	4-1/2"	4-1/2"	5"	5"	11"	11"
Ansonia Roman	73.520	73.530	73.540	73.550	73.560	73.570
Ansonia Arabic	73.420	73.430	73.440	73.450	73.460	73.470
Ansonia Calendar	N/A	N/A	N/A	N/A	73.370	73.371
Gilbert Roman	73.521	73.531	73.541	73.551	73.561	N/A
Gilbert Arabic	73.421	73.431	73.441	73.451	73.461	N/A
Ingraham Roman	73.522	73.532	73.542	73.552	N/A	73.572
Ingraham Arabic	73.422	N/A	73.442	73.452	73.462	73.472
Ingraham Calendar	N/A	N/A	N/A	N/A	73.372	73.373
Kroeber Roman	73.523	73.533	73.543	73.553	N/A	N/A
New Haven Roman	73.524	73.534	73.544	73.554	73.564	73.574
New Haven Arabic	73.424	73.434	73.444	73.454	73.464	73.474
Sessions Roman	73.525	73.535	73.545	73.555	73.565	73.575
Sessions Arabic	73.425	73.435	73.445	73.455	N/A	73.475
Sessions Calendar	N/A	N/A	N/A	N/A	73.374	73.375
Seth Thomas Roman	73.526	73.536	73.546	73.556	N/A	73.576
Seth Thomas Arabic	73.426	73.436	73.446	73.456	N/A	N/A
Waterbury Roman	73.527	73.537	73.547	73.557	73.567	73.577
Waterbury Arabic	73.427	73.437	73.447	73.457	N/A	73.477
Waterbury Calendar	N/A	N/A	N/A	N/A	73.376	73.377
E. N. Welch Roman	73.528	73.538	73.548	73.558	N/A	73.578
E.N. Welch Arabic	73.428	73.438	73.448	73.458	73.468	73.478
1.25 ea. 12 or more 1.00 ea.			1.50 ea. 12 or more 1.25 ea.		\$ 2.50 ea. 12 or more \$ 2.25 ea.	

No maker paper dial (plain)
Come in white & Ivory.
Ivory dial have a off-white
Appearance. Measurement
Are across time track.

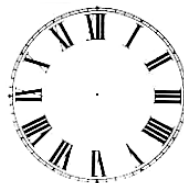

**Roman
No
Maker**

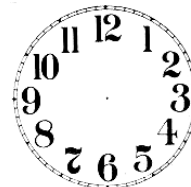

**Arabic
No
Maker**

Size	Arabic White	Roman White	Arabic Ivory	Roman Ivory	Size	Arabic White	Roman White	Arabic Ivory	Roman Ivory
1-3/4"	N/A	73.930	N/A	73.960	5-1/2"	73.845	73.945	73.876	73.975
2"	N/A	73.931	N/A	N/A	5-3/4"	73.846	73.946	73.877	73.976
2-1/4"	N/A	N/A	N/A	73.962	6"	73.847	N/A	N/A	N/A
2-1/2"	73.833	73.933	N/A	73.963	6-1/4"	73.848	73.948	73.879	73.978
2-3/4"	N/A	73.934	N/A	73.964	6-1/2"	73.849	73.949	73.880	73.979
3"	73.835	N/A	73.866	73.965	6-3/4"	73.850	73.950	73.881	N/A
3-1/4"	73.836	73.936	73.867	73.966	7"	73.851	73.951	73.882	73.981
3-1/2"	N/A	73.937	73.868	73.967	7-1/2"	73.852	73.952	73.883	N/A
3-3/4"	73.838	73.938	73.869	N/A	8"	73.853	N/A	73.884	N/A
4"	N/A	73.939	N/A	73.969	8-1/2"	73.854	N/A	N/A	73.984
4-1/4"	73.840	73.940	73.871	73.970	9"	73.855	73.955	73.886	73.985
4-1/2"	73.841	73.941	73.872	73.971	10"	N/A	N/A	73.887	73.986
4-3/4"	73.842	73.942	73.873	N/A	11"	73.857	73.957	73.888	73.987
5"	73.843	73.943	73.874	73.973	12"	73.858	73.958	73.889	N/A
5-1/4"	73.844	73.944	73.875	73.974					
Sizes 1-3/4" to 4-1/2"			Sizes 4-3/4" to 7-1/2"			Sizes 8" to 12"			
1.25 ea. 12 or more 1.00 ea.			\$ 1.75 ea. 12 or more \$1.50 ea.			\$ 2.50 ea. 12 or more \$ 2.25 ea.			

Prices Subject To Change Without Notice.

O G Dials

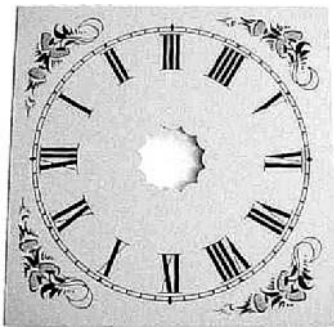

1 Day and 8 Day OG Dials

Metal dial with off white background and black numbers. Corners have Red and Green

with a scallop center.

- 73.491 ... 1 Day 8-1/2" Square 7-1/4" Time Track ... \$ 14.00
- 73.492 ... 8 Day 9-1/2" Square 8" Time Track \$ 14.00

Dial Pans



Steel dial pans brass plated. Measurement of dial pans are from out side to out side. Recessed to fit clock case opening. Center hole are predrilled.

- 73.580 4-3/4" \$ 13.00 ea.
- 73.581 5" \$ 13.00 ea.
- 73.583 5-1/4" \$ 13.00 ea.
- 73.584 5-1/2" \$ 13.00 ea.
- 73.585 5-3/4" \$ 13.00 ea.
- 73.586 6" \$ 13.00 ea.
- 73.589 8-5/8" \$ 19.50 ea.
- 73.582 8-7/8" \$ 19.50 ea.
- 73.590 10-1/2" \$ 20.50 ea.
- 73.591 10-7/8" \$ 20.50 ea.
- 73.592 12-5/8" \$ 22.00 ea.
- 73.593 13-1/8" \$ 22.00 ea.

Kitchen Clock Dial Pan



Kitchen Clock Dials 6-3/8" out side Diameter. With small hole & scallop Alarm hole.

- 73.587 Small hole \$ 15.00 ea.
- 73.588 Scallop hole ... \$ 16.00 ea.

Prices Subject To Change Without Notice.

Bezel With Inter Ring



Brass Bezel with a Inter Retaining Ring to Hold the glass in place. Hinge Package Included.

- 73.720 ... 7-1/4" Bezel \$ 26.25
- 73.721 ... 8.-1/2" Bezel \$ 26.25

Dial Pan



7-1/8" Dial Pan to work with 7-1/4" Bezel. Can use a 6" Paper dial.

- 8-3/8" Dial Pan to work with the 8-1/2 Bezel. Can use and 7" Paper dial.
- 73.595 7-1/8" \$ 14.00
- 73.596 8-3/8" \$ 16.00

Bezel Dial Pan Combinations



Arabic Roman

Bezel and Dial Pan are not Hinged So they will need to be mounted to the case.

- 73.597 ... 5-1/8" Roman ... \$ 23.50 ea.
- 73.598 ... 5-1/8" Arabic ... \$ 23.50 ea.
- 73.599 ... 6-1/4" Roman ... \$ 25.50 ea.
- 73.600 ... 6-1/4" Arabic ... \$ 25.50 ea.

Reverse Time Dials



Reverse Dial come in two sizes 6-1/2" or 9-1/2"

- 15.383 6-1/2" \$ 5.25 ea.
- 15.384 9-1/2" \$ 5.50 ea.

Bezel Glass Tabs

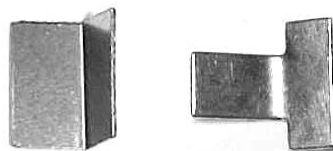

T Tab

- Pre formed brass glass tabs. 12 pc
- 73.700 ... 3/8" X 3/8" ... \$ 2.25 pkg.
- 73.701 ... 3/8" X 1/2" ... \$ 2.25 pkg.
- Pre formed brass glass T tabs . 12 pc
- 73.702 ... 3/8" X 7/16" ... \$ 2.25 pkg.
- 73.703 ... 1/2" X 5/8" \$ 2.25 pkg.

Brass Dial Grommets



Winding hole grommets.

- Size 1/2" OD X 3/8" ID 10 Teeth 12 pieces to a package.
- GR 600 \$ 1.75 pkg.
- 3 or more pkg. \$ 1.50 pkg.
- Winding hole grommets.
- Size 9/16" OD X 7/16" ID 10 Teeth 12 pieces to a package.
- GR100 \$ 1.75 pkg.
- 3 or more pkg. \$ 1.50 pkg.
- Winding hole grommets.
- Size 5/8" OD X 7/16" ID 10 Teeth 12 pieces to a package.
- GR 200 \$ 1.75 pkg.
- 3 or more pkg. \$ 1.50 pkg.
- Winding hole grommets.
- Size 3/4" OD X 1/2" ID 10 Teeth 6 pieces to a package.
- GR300 \$ 2.25 pkg.
- 3 or more pkg. \$ 2.00 pkg.

Brass Grommets Old Style



- 7/16" OD X 5/16" ID 12 pc.
- GR500 \$ 1.75 ea.

Brass Dial Grommets



- Assortment of Brass hole grommets.
- Sizes 6 pc. 9/16 OD X 7/16 ID
- 6 pc. 5/8 OD X 7/16 ID 12 pieces to a package.
- GR400 \$ 1.75 pkg.
- 3 or more pkg. \$ 1.50 pkg.

Dial Cutter



Paper dial cutter for cutting perfect circle Every time. Cut circle from 2" to 16".

- 73.500 \$ 14.00 ea.
- Extra Blades 2 per Pkg.**
- 73.499 \$ 1.50 ea

Chime Rods



Copper Chime Rods
6.4 Thread Diameter

- 73.112 12" long 2.8 mm Rod Dia.
- 73.114 14" long 2.8 mm Rod Dia.
\$ 6.50 ea.



Steel Chime Rods
6.4 Thread Diameter

- 73.115 ... 15" long 3.30 mm Rod Dia.
- 73.116 ... 18" long 3.30 mm Rod Dia.
- 73.117 ... 21" long 3.30 mm Rod Dia.
- 73.119 ... 26" long 3.30 mm Rod Dia.

- 73.215 ... 15" long 3.60 mm Rod Dia.
- 73.216 ... 18" long 3.60 mm Rod Dia.
- 73.217 ... 21" long 3.60 mm Rod Dia.
- 73.218 ... 24" long 3.60 mm Rod Dia.
- 73.219 ... 26" long 3.60 mm Rod Dia.
\$ 6.00 ea.

8.00 mm Thread Steel Chime Rod



- Steel Chime rod 3.60 rod dia. 26" long
73.220 \$ 7.00 ea.

Tuned Chime Rod



Chime rod set 6.4 (1/4) thread un mounted.
The size is the longest rod in the set.

- 73.400 ... 7" Copper set 5 \$ 27.50 set.
- 73.401 ... 10" Copper set 4..... \$ 22.00 set.
- 73.402 ... 19" steel set 4 \$ 23.50 set.
- 73.405 ... 22" steel set 4 \$ 24.00 set.
- 73.403 ... 26" steel set 4 \$ 24.50 set.
- 73.408 ... 26" steel set 4 **8.00 mm Thread**
\$ 24.75 Set

- 73.404 ... 17-1/2" steel set 8 ... \$ 43.50 set.
- 73.407 ... 22-1/2" steel set 8 ... \$ 44.50 set.
- 73.406 ... 26" Steel set 8 \$ 42.75 set.

NOTE: 73.406 set is 4 rod Chime 4 Rod Strike

- 73.409 ... 26" Steel Set 12 \$ 63.75 set

NOTE: 73.409 Set Triple Chime & Strike Rod.

Flat Wire Gong



- 3" Flat wire gong with brass end.
73.350 \$ 4.00 ea.

Prices Subject To Change Without Notice.

Wire Gong With Center Mount

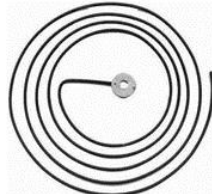

- 4-1/2" round wire gong
73.352 \$ 3.50 ea.

Heavy Wire Gong With Center Mount



- 5-1/8" Heavy round wire gong.
73.353 \$ 22.50 ea.

4-1/4" Gong

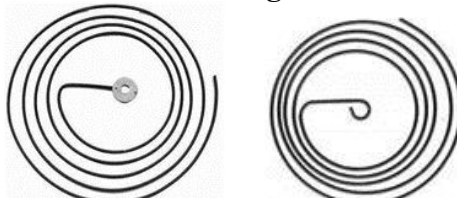

- 73.357 \$ 3.25 ea.
- 73.358 \$ 2.50 ea.
- 4-1/4" Wire gong with Washer and with Loop
73.357 \$ 3.25 ea.
- 73.358 \$ 2.50 ea.

Cuckoo Gong with Bracket



- 73.359 3-1/2" \$ 2.50 ea
- 73.360 4" \$ 2.75ea.

Gong Base



- Cast black gong base 2-1/2" diameter
73.351 \$ 3.75 ea.

Chime Hammers

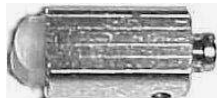

- Chime hammer for grandmother and
Grandfather clocks.
- 73.120 5/8" long \$ 1.75 ea.
- 73.121 7/8" long \$ 2.00 ea.

Hammer Return Springs



Hammer return springs are measured from end to end. Used on German Striking Clocks.

- 73.125 ... 7/16" Long \$ 0.65 ea.
- 73.126 ... 1/2" Long \$ 0.65 ea.
- 73.127 ... 5/8" Long \$ 0.65 ea.
- Kieninger Hammer Spring for KSU
73.128 ... 31/32" Long \$ 0.85 ea.



- Strike Return Leaf Spring Kieninger KSU
73.129 \$ 0.50 ea.

Mantel Clock Base with Gong

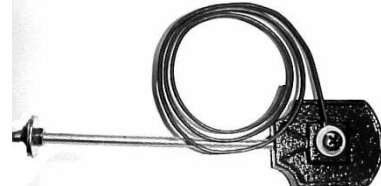

Mantel Clock base with 3" gong, rod is 4-5/8" long over all. Rod may be shorten to fit the case. Threads are M5.

- 73.354 \$ 20.00 ea.

Tap, Drill and Die for Chime Rod End



Tap, Dies and drill for drilling to install chime rod in chime blocks.

- Tap in 6.5 X 1 mm & 8.0 X 1 mm**
- 28.609 6.5 X 1.0 mm tap ... \$ 12.50
- 28.610 8.0 X 1.0 mm tap ... \$ 6.50



- Drill 28.650 is for tap 28.609
- 28.650 ... 5.4 mm Drill ... \$ 3.75
- Drill 28.651 is for tap 28.610
- 28.651 ... 7.0 mm Drill ... \$ 3.75



- Die for Chime Rod ends**
- M 6.5 X 1.0 mm Die
28.520 \$ 15.00

Hammer Replacement Leather.



Round leather used to replace the end of clock hammers. Comes in 1 foot length
Sizes available 1/8", 3/16", and 1/4" dia.

- HM180 ... 1/8" diameter \$ 1.75 ea.
- HM310 ... 3/16" diameter \$ 2.00 ea.
- HM140 ... 1/4" diameter \$ 2.50 ea.

Dumont Tweezers

- 57.200 ... # 1 Carbon Steel \$ 31.50
- 57.208 ... # 2 Carbon Steel \$ 30.50
- 57.217 ... # 3 Carbon Steel \$ 32.25
- 57.225 ... # 3C Carbon Steel ... \$ 31.25
- 57.252... # 3C nonmagnetic \$ 26.50
- 57.431 ... # 4 Carbon Steel \$ 34.25
- 57.235 ... # 5 Carbon Steel \$ 36.50
- 57.254... # 5 nonmagnetic \$ 30.00
- 57.256 ... # 8 Carbon Steel \$ 81.25
- Economy AA tweezers**
- 57.0738 ... # AA Stainless Steel .. \$ 3.00

Tweezer Set



Set of 5 Tweezer 5" long. All purpose stainless steel non-magnetic. The set has AA, MM, NN, #3, & #5.

57.105 \$11.50 set.

Bergeon Watch Tool



Bergeon Plastic Tweezers for handling Watch batteries.

6460 \$ 5.00 ea.

Prices Subject To Change Without Notice.

French Bell Stand



Brass formed French Bell stand with nut. 2" long.

71.040 \$ 5.00 ea.



Brass French bell stand nut. 4-40 thread.

71.041 \$ 1.50 ea.

Brass Bells



- 71.028 2" dia. \$ 7.25 ea.
- 71.029 2-1/4" dia. \$ 8.25 ea.
- 71.030 2-1/2" dia. \$ 11.50 ea.
- 71.031 3" dia. \$ 13.50 ea.
- 71.033 3-1/2" dia. \$ 19.50 ea.
- 71.032 4" dia. \$ 25.25 ea.
- 71.034 4-1/2" dia \$ 30.00 ea.
- 71.035 5" dia. \$ 33.50 ea.

Tall Case Bell Stand



Bell stand for Old English, Tall Case & Etc. 5-1/4" long.

71.042 \$ 16.50 ea.

Weight Shell Hooks



M4 Thread M5 Thread M5 Thread M4 Thread
79.420 79.421 79.422 79.423

Brass weight shell hook & bottom.

\$ 1.75 ea. 3 or more \$ 1.50 ea.

Vienna & Regulator Weight Hooks



79.424 79.425 79.426

Solid brass hooks 8-32 thread.

79.424 5/8" Vienna ... \$ 2.50 ea.

79.425 7/8" w/ screw .. \$ 3.00 ea.

79.426 ... ST # Regulator ... \$ 4.00 ea.

79.426 thread is 5-40.

Eye Loops For Spectacle

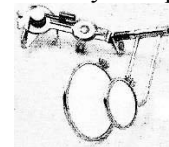

Double Loop
29.311 ... 4X,7X
29.739 ... 4X,10X
\$ 31.75 ea.



Single Loop
29.323 ... 3-1/2X
29.325 ... 2-1/2X
\$ 20.75 ea.

Eye Loops For Spectacle made By B&L



29.169 ... 4X,7X
\$ 48.50



29.164 ... 7X
29.166 ... 4X
\$ 38.50

Optivisors



Features a dial adjustment headband to fit any head size. Will fit over eye glasses.

Working

Part No.	Distance	Power	Price
29.472	10"	2X	\$ 49.75 ea.
29.473	8"	2-1/2X	\$ 49.75 ea.

Other optivisor available on special order.



Complete head piece less lenses.

29.492 \$ 30.25

Replacement lenses



Part No.	Distance	Power	Price
29.485	20"	1-1/2X	\$ 32.75
29.486	14"	1-3/4X	\$ 32.75
29.487	10"	2X	\$ 32.75
29.488	8"	2-1/2X	\$ 32.75
29.489	6"	2-3/4X	\$ 33.75
29.490	4"	3-1/2X	\$ 33.75

Optiloup for Optivisors.



This loop adds 2-1/2 X to the Magnification. Easily attached to either Eye of optivisor. Swing away when not In use.

29.491 \$ 13.50

Optivisor Add on Light

Uses 2 AA Batteries (not Included)
42" Cord
29.495 \$ 27.75

29.497 ... Replacement Bulb ... \$ 10.50

Vienna Regulator Shell



- 79.407 \$ 16.50 ea.
 79.408 Complete Shell & Weight \$ 37.00 ea.
 79.448 \$ 16.50 ea.
 79.449 Complete Shell & Weight \$ 37.00 ea.

Grandmother & Grandfather Weight Shell



Polished Weight Shells

- Shells come with caps, center rod and top Hook and bottom nib
- 79.400 ... Weight Shell 1-5/8" X 9-1/8" (42mm) \$ 16.50 ea.
 79.401 ... Weight Shell 1-7/8" X 11" (48mm) \$ 20.50 ea.
 79.409 ... Weight Shell 1-7/8" X 9-5/8" (48mm) \$ 20.00 ea.
 79.402 ... Weight Shell 2-3/8" X 9-5/8" (60mm) \$ 21.00 ea.
 79.428 ... Weight Shell 2-3/8" X 11" (60mm) \$ 22.00 ea.

Fancy Polished Weight Shell



- Polished Shell With End Cap, Rod & Hook
- 79.446 ... Weight Shell 2-3/8" X 9-5/8" (60mm) \$ 23.50 ea.



- Polished Shell With End Cap, Rod & Hook
- 79.447 ... Weight Shell 2-3/8" X 9-5/8" (60mm) ... German Style \$ 35.00

Polished Weight End Caps



- 79.403 ... End Caps 1-5/8" 42 mm
 79.415 ... End Caps 1-7/8" 48 mm
 79.404 ... End Caps 2-3/8" 60 mm \$ 3.00 ea.

Prices Subject To Change Without Notice.

ST # 2 Regulator Weight Shell



- Solid brass shell with hook. The shell are a dull finish and are ready to be polished.
- 1-3/4" dia. X 6-1/4" Long.
- 79.405 \$ 30.50 ea.
 79.406 Complete Shell & Weight \$ 53.00 ea.

ST # 3 Regulator Weight Shell



- Solid brass shell with hook & Rounded Caps. The shell are a dull finish and are ready to be polished. 2" dia. X 6-1/4" Long.
- 79.431 \$ 49.75 ea.
 79.432 Complete Shell & Weight \$ 76.50 ea.

Lead Weight Inserts



- 79.410 ... 4-1/2 lb. ... 1-5/8" X 5-3/4" \$ 28.50 ea.
 79.411 ... 7-1/2 lb. ... 1-5/8" X 9-1/4" \$ 40.00 ea.
 79.412 ... 9-3/4 lb. 1-3/4" X 10-1/4" \$ 49.75 ea.
 79.413 Vienna Weight 3-1/2 lb 1-5/8" X 4-3/8" \$ 22.00 ea.
 79.414 ... ST # 2 regulator Weight 5lb. ... 1-5/8" X 5-7/8" \$ 25.00 ea.
 79.430 ... ST # 3 regulator Weight 6-1/4lb. ... 1-3/4" X 5-7/8" \$ 31.00 ea.

Weight Shell Rods



- Rod ends are M 4 Thread
- 79.460 9-1/2" Long \$ 2.50 ea.
 79.461 10-1/8" Long \$ 2.50 ea.
 79.462 12-13/16" Long ... \$ 3.50 ea.

Weight Shell Hooks



- M4 Thread M5 Thread M5 Thread M4 Thread
- 79.420 79.421 79.422 79.423
- Brass weight shell hook & bottom. \$ 1.75 ea. 3 or more \$ 1.50 ea.

Lead Fillers for Weight Shells



- #### 1 Pound Weight fillers
- | Width | Weight | Diameter | Shell Diameter |
|--------|---------------|------------------|----------------|
| 79.435 | ... 1-9/16 .. | 38 mm (1-7/16") | .. 40 mm |
| 79.436 | ... 1-3/8 .. | 44 mm (1-11/16") | .. 45 mm |
| 79.437 | ... 7/8 .. | 48 mm (1-7/8") | 50 mm |
| 79.438 | ... 5/8 .. | 58 mm (2-1/4") | 60 mm |
- \$ 7.00 ea. 3 or more \$ 6.75 ea.

- #### 1/2 Pound Weight fillers
- | Width | Weight | Diameter | Shell Diameter |
|--------|------------|------------------|----------------|
| 79.439 | ... 3/4 .. | 38 mm (1-7/16") | 40 mm |
| 79.440 | ... 5/8 .. | 44 mm (1-11/16") | ... 45 mm |
| 79.441 | ... 1/2 .. | 48 mm (1-7/8") | 50 mm |
| 79.442 | ... 3/8 .. | 58 mm (2-1/4") | 60 mm |
- \$ 3.75 ea. ... 3 or more \$ 3.50 ea.

Cast Iron OG Weights 8Day



- 8 Day Weight W/Top Hook
- 5-3/8" H X 2-7/8" W X 2-5/8"D
- 79.419 8-3/4 lb ... \$ 41.00 ea.
 5" H X 3-1/4" W X 2-1/4" D
 79.427 ... 7 lb. \$ 32.00 ea.

Cast Iron OG Weights 30 Hour



- 30 Hour Weight W/TopHook
- 79.417 ... 2-1/8" dia. X 3-1/2" H
 79.418 ... 2-1/2" dia. X 3-3/4" H
 79.417 ... 3 lb. \$ 17.50 ea.
 79.418 ... 4 lb. \$ 21.50 ea.

Cast Iron Tall Case Weight W/Hook



- 10-3/8" Long X 2-7/8" Diameter
- 79.416 14 lb. \$ 57.00 ea.
 7-1/4" Long X 2-3/4" Diameter
 79.434 10-1/2 lb. \$ 46.00 ea.

Lead Counterweight

Used as counterweight on Clock Chain



- 1-3/4" Diameter 4-1/2 oz.
 79.399 \$ 4.50 ea.

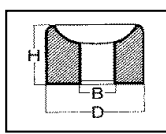

Bergeon Brass Bushing System

Bushing Number	Reamer Number	"D" Out Side Diameter	"H" Height	"B" Inside Diameter	Bushing Number	Reamer Number	"D" Out Side Diameter	"H" Height	"B" Inside Diameter
5699A/ 1	1.97 mm	2.0 mm	1.5mm	0.40 mm	5699A/ 31	1.97 mm	2.0 mm	1.5mm	0.30 mm
5699A/ 2	1.97 mm	2.0 mm	1.5mm	0.50 mm	5699A/ 32	1.97 mm	2.0 mm	1.5mm	0.35 mm
5699A/ 3	1.97 mm	2.0 mm	1.5mm	0.60 mm	5699A/ 33	1.97 mm	2.0 mm	2.0mm	0.40 mm
5699A/ 4	1.97 mm	2.0 mm	3.0mm	0.60 mm	5699A/ 34	1.97 mm	2.0 mm	2.0mm	0.45 mm
5699A/ 5	1.97 mm	2.0 mm	1.5mm	0.70 mm	5699A/ 35	1.97 mm	2.0 mm	1.2mm	0.50 mm
5699A/ 6	1.97 mm	2.0 mm	3.0mm	0.70 mm	5699A/ 36	1.97 mm	2.0 mm	2.0mm	0.50 mm
5699A/ 7	2.47 mm	2.5 mm	1.5mm	0.80 mm	5699A/ 37	1.97 mm	2.0 mm	1.5mm	0.55 mm
5699A/ 8	2.47 mm	2.5 mm	3.0mm	0.80 mm	5699A/ 38	1.97 mm	2.0 mm	2.0mm	0.65 mm
5699A/ 9	2.47 mm	2.5 mm	1.5mm	0.90 mm	5699A/ 39	1.97 mm	2.0 mm	2.0mm	0.75 mm
5699A/ 10	2.47 mm	2.5 mm	3.0mm	0.90 mm	5699A/ 40	2.47 mm	2.5 mm	2.0mm	0.85 mm
5699A/ 11	2.97 mm	3.0 mm	1.5mm	1.00 mm	5699A/ 41	2.47 mm	2.5 mm	1.2mm	0.95 mm
5699A/ 12	2.97 mm	3.0 mm	3.0mm	1.00 mm	5699A/ 42	2.97 mm	3.0 mm	2.0mm	1.00 mm
5699A/ 13	2.97 mm	3.0 mm	1.5mm	1.25 mm	5699A/ 43	2.97 mm	3.0 mm	2.0mm	1.10 mm
5699A/ 14	2.97 mm	3.0 mm	3.0mm	1.25 mm	5699A/ 44	2.97 mm	3.0 mm	2.0mm	1.20 mm
5699A/ 15	3.47 mm	3.5 mm	1.5mm	1.50 mm	5699A/ 45	2.97 mm	3.0 mm	2.0mm	1.25 mm
5699A/ 16	3.47 mm	3.5 mm	3.0mm	1.50 mm	5699A/ 46	2.97 mm	3.0 mm	2.0mm	1.30 mm
5699A/ 17	3.47 mm	3.5 mm	1.5mm	1.75 mm	5699A/ 47	3.47 mm	3.5 mm	2.0mm	1.40 mm
5699A/ 18	3.47 mm	3.5 mm	3.0mm	1.75 mm	5699A/ 48	3.47 mm	3.5 mm	2.0mm	1.50 mm
5699A/ 19	4.47 mm	4.5 mm	1.5mm	2.00 mm	5699A/ 49	3.47 mm	3.5 mm	3.0mm	1.60 mm
5699A/ 20	4.47 mm	4.5 mm	3.0mm	2.00 mm	5699A/ 50	3.47 mm	3.5 mm	3.0mm	1.65 mm
5699A/ 21	4.47 mm	4.5 mm	1.5mm	2.25 mm	5699A/ 51	3.47 mm	3.5 mm	2.0mm	1.70 mm
5699A/ 22	4.47 mm	4.5 mm	3.0mm	2.25 mm	5699A/ 52	3.47 mm	3.5 mm	2.0mm	1.80 mm
5699A/ 23	4.47 mm	4.5 mm	1.5mm	2.50 mm	5699A/ 53	3.47 mm	3.5 mm	2.0mm	1.90 mm
5699A/ 24	4.47 mm	4.5 mm	3.0mm	2.50 mm	5699A/ 54	4.47 mm	4.5 mm	2.0mm	2.00 mm
5699A/ 25	5.47 mm	5.5 mm	1.5mm	3.00 mm	5699A/ 55	4.47 mm	4.5 mm	2.0mm	2.10 mm
5699A/ 26	5.47 mm	5.5 mm	3.0mm	3.00 mm	5699A/ 56	4.47 mm	4.5 mm	2.0mm	2.25 mm
5699A/ 27	6.47 mm	6.5 mm	1.5mm	4.00 mm	5699A/ 57	4.47 mm	4.5 mm	2.0mm	2.40 mm
5699A/ 28	6.47 mm	6.5 mm	3.0mm	4.00 mm	5699A/ 58	4.47 mm	4.5 mm	2.0mm	2.75 mm
5699A/ 29	7.47 mm	7.5 mm	3.0mm	5.00 mm	5699A/ 59	8.47 mm	8.5 mm	2.0mm	5.00 mm
5699A/ 30	8.47 mm	8.5 mm	3.0mm	6.00 mm	5699A/ 60	8.47 mm	8.5 mm	2.0mm	6.50 mm

Bergeon Brass Bushing: pkg. of 10 pc. & 100 pc.
Order No. 5699A/ No. 1 to 24, 31 to 58 for pkg of 10 pc.
 1 to 5 pkg. ... \$ 4.00 ea. ... 6 or more pkg. ... \$ 3.75 ea.
Order No. 5699A/ No. 1 to 24 31 to 58 for pkg. of 100pc.
 1 to 5 pkg. ... \$ 28.00 ea. ... 6 or more pkg. ... \$ 27.75 ea.
Order No. 5699A/ No. 25 to 30, 59 to 60 for pkg of 10 pc.
 1 to 5 pkg. ... \$ 5.75 ea. ... 6 or more pkg. ... \$ 5.50 ea.
Order No. 5699A/ No. 25 to 30 59 to 60 for pkg. of 100pc.
 1 to 5 pkg. ... \$ 48.75 ea. ... 6 or more pkg. ... \$ 48.50 ea.

BERGEON REAMERS (Swiss Made)



Replacement Reamers for Bergeon Bushing	
6200/14	1.20 mm
6200/15	1.97 mm
6200/16	2.47 mm
6200/17	2.97 mm
6200/18	3.47 mm
6200/19	4.47 mm
6200/20	5.47 mm
6200/21	6.47 mm
6200/22	7.47 mm
6200/23	8.47 mm
\$ 22.50 ea. 3 or more	\$ 22.25 ea.
6200/25 .. chamfering cutter	10 mm
	\$ 25.75 ea.

BERGEON BUSHING ASSORTMENT

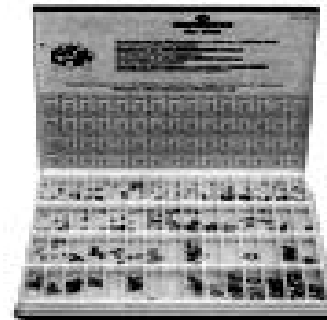

5488Brass..... 450 pc. \$ 159.50
 5816Bronze..... 450 pc. \$ 235.00

BERGEON REAMERS (USA Made)



Replacement Reamers for Bergeon Bushing	
6200/15 A	1.97 mm
6200/16 A	2.47 mm
6200/17 A	2.97 mm
6200/18 A	3.47 mm
6200/19 A	4.47 mm
\$ 16.00 ea. 3 or more	\$ 15.75 ea.

Prices Subject To Change Without Notice.

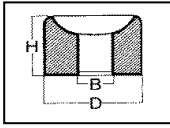

“NEW” American Made Bergeon Brass Bushing System

American Made Bergeon Brass Bushing comes in packages of 20 pieces.

465BB/01-24,31-58,101-110,301-335 \$ 5.25 pkg. 6 to 11 pkg. \$ 5.00 pkg. 12 and up \$ 4.75 pkg.

4165BB/25-30,59,60,,123,126 \$ 7.50 pkg. 6 to 11 pkg. \$ 7.25 pkg. 12 and up \$ 7.00 pkg.

Bushing Number	Reamer Number	“D” OutSide Diameter	“H” Height	“B”Inside Diameter	Bushing Number	Reamer Number	“D”Out Side Diameter	“H” Height	“B”Inside Diameter
5699BB 35	1.97 mm	2.0 mm	1.2mm	0.50 mm	5699BB 317	3.47 mm	3.5 mm	1.5mm	1.80 mm
5699BB 31	1.97 mm	2.0 mm	1.5mm	0.30 mm	5699BB 318	3.47 mm	3.5 mm	1.5mm	1.90 mm
5699BB 32	1.97 mm	2.0 mm	1.5mm	0.35 mm	5699BB 337	3.47 mm	3.5 mm	2.0mm	1.00 mm
5699BB 01	1.97 mm	2.0 mm	1.5mm	0.40 mm	5699BB 338	3.47 mm	3.5 mm	2.0mm	1.10 mm
5699BB 02	1.97 mm	2.0 mm	1.5mm	0.50 mm	5699BB 320	3.47 mm	3.5 mm	2.0mm	1.20 mm
5699BB 37	1.97 mm	2.0 mm	1.5mm	0.55 mm	5699BB 321	3.47 mm	3.5 mm	2.0mm	1.30 mm
5699BB 03	1.97 mm	2.0 mm	1.5mm	0.60 mm	5699BB 47	3.47 mm	3.5 mm	2.0mm	1.40 mm
5699BB 05	1.97 mm	2.0 mm	1.5mm	0.70 mm	5699BB 48	3.47 mm	3.5 mm	2.0mm	1.50 mm
5699BB 301	1.97 mm	2.0 mm	1.5mm	0.95 mm	5699BB 50	3.47 mm	3.5 mm	2.0mm	1.65 mm
5699BB 341	1.97 mm	2.0 mm	2.0mm	0.30 mm	5699BB 51	3.47 mm	3.5 mm	2.0mm	1.70 mm
5699BB 33	1.97 mm	2.0 mm	2.0mm	0.40 mm	5699BB 52	3.47 mm	3.5 mm	2.0mm	1.80 mm
5699BB 34	1.97 mm	2.0 mm	2.0mm	0.45 mm	5699BB 53	3.47 mm	3.5 mm	2.0mm	1.90 mm
5699BB 36	1.97 mm	2.0 mm	2.0mm	0.50 mm	5699BB 339	3.47 mm	3.5 mm	3.0mm	1.00 mm
5699BB 38	1.97 mm	2.0 mm	2.0mm	0.65 mm	5699BB 340	3.47 mm	3.5 mm	3.0mm	1.10 mm
5699BB 39	1.97 mm	2.0 mm	2.0mm	0.75 mm	5699BB 323	3.47 mm	3.5 mm	3.0mm	1.20 mm
5699BB 0	1.97 mm	2.0 mm	2.6mm	0.30 mm	5699BB 324	3.47 mm	3.5 mm	3.0mm	1.30 mm
5699BB 00	1.97 mm	2.0 mm	2.6mm	0.40 mm	5699BB 325	3.47 mm	3.5 mm	3.0mm	1.40 mm
5699BB 304	1.97 mm	2.0 mm	3.0mm	0.40 mm	5699BB 16	3.47 mm	3.5 mm	3.0mm	1.50 mm
5699BB 305	1.97 mm	2.0 mm	3.0mm	0.50 mm	5699BB 326	3.47 mm	3.5 mm	3.0mm	1.60 mm
5699BB 04	1.97 mm	2.0 mm	3.0mm	0.60 mm	5699BB 18	3.47 mm	3.5 mm	3.0mm	1.75 mm
5699BB 06	1.97 mm	2.0 mm	3.0mm	0.70 mm	5699BB 327	3.47 mm	3.5 mm	3.0mm	1.80 mm
5699BB 101	1.97 mm	2.0 mm	5.0mm	0.80 mm	5699BB 328	3.47 mm	3.5 mm	3.0mm	1.90 mm
5699BB 102	1.97 mm	2.0 mm	5.0mm	1.00 mm	5699BB 330	4.47 mm	4.5 mm	1.5mm	1.90 mm
5699BB 07	2.47 mm	2.5 mm	1.5mm	0.80 mm	5699BB 19	4.47 mm	4.5 mm	1.5mm	2.00 mm
5699BB 09	2.47 mm	2.5 mm	1.5mm	0.90 mm	5699BB 21	4.47 mm	4.5 mm	1.5mm	2.25 mm
5699BB 41	2.47 mm	2.5 mm	2.0mm	0.80 mm	5699BB 23	4.47 mm	4.5 mm	1.5mm	2.50 mm
5699BB 40	2.47 mm	2.5 mm	2.0mm	0.85 mm	5699BB 332	4.47 mm	4.5 mm	2.0mm	1.90 mm
5699BB 308	2.47 mm	2.5 mm	2.0mm	0.90 mm	5699BB 54	4.47 mm	4.5 mm	2.0mm	2.00 mm
5699BB 08	2.47 mm	2.5 mm	3.0mm	0.80 mm	5699BB 55	4.47 mm	4.5 mm	2.0mm	2.10 mm
5699BB 10	2.47 mm	2.5 mm	3.0mm	0.90 mm	5699BB 56	4.47 mm	4.5 mm	2.0mm	2.25 mm
5699BB 103	2.47 mm	2.5 mm	5.0mm	1.00 mm	5699BB 57	4.47 mm	4.5 mm	2.0mm	2.40 mm
5699BB 104	2.47 mm	2.5 mm	5.0mm	1.20 mm	5699BB 333	4.47 mm	4.5 mm	2.0mm	2.50 mm
5699BB 106	2.47 mm	2.5 mm	5.0mm	1.40 mm	5699BB 58	4.47 mm	4.5 mm	2.0mm	2.75 mm
5699BB 109	2.47 mm	2.5 mm	5.0mm	1.05 mm	5699BB 335	4.47 mm	4.5 mm	3.0mm	1.90 mm
5699BB 11	2.97 mm	3.0 mm	1.5mm	1.00 mm	5699BB 20	4.47 mm	4.5 mm	3.0mm	2.00 mm
5699BB 13	2.97 mm	3.0 mm	1.5mm	1.25 mm	5699BB 22	4.47 mm	4.5 mm	3.0mm	2.25 mm
5699BB 42	2.97 mm	3.0 mm	2.0mm	1.00 mm	5699BB 24	4.47 mm	4.5 mm	3.0mm	2.50 mm
5699BB 43	2.97 mm	3.0 mm	2.0mm	1.10 mm	5699BB 121	4.47 mm	4.5 mm	5.0mm	3.00 mm
5699BB 44	2.97 mm	3.0 mm	2.0mm	1.20 mm	5699BB 25	5.47 mm	5.5 mm	1.5mm	3.00 mm
5699BB 45	2.97 mm	3.0 mm	2.0mm	1.25 mm	5699BB 26	5.47 mm	5.5 mm	3.0mm	3.00 mm
5699BB 46	2.97 mm	3.0 mm	2.0mm	1.30 mm	5699BB 27	6.47 mm	6.5 mm	1.5mm	4.00 mm
5699BB 12	2.97 mm	3.0 mm	3.0mm	1.00 mm	5699BB 28	6.47 mm	6.5 mm	3.0mm	4.00 mm
5699BB 14	2.97 mm	3.0 mm	3.0mm	1.25 mm	5699BB 123	6.47 mm	6.5 mm	5.0mm	4.50 mm
5699BB 105	2.97 mm	3.0 mm	5.0mm	1.20 mm	5699BB 29	7.47 mm	7.5 mm	3.0mm	5.00 mm
5699BB 107	2.97 mm	3.0 mm	5.0mm	1.40 mm	5699BB 59	8.47 mm	8.5 mm	2.0mm	5.00 mm
5699BB 108	2.97 mm	3.0 mm	5.0mm	1.60 mm	5699BB 60	8.47 mm	8.5 mm	2.0mm	6.50 mm
5699BB 110	2.97 mm	3.0 mm	5.0mm	1.80 mm	5699BB 30	8.47 mm	8.5 mm	3.0mm	6.00 mm
5699BB 336	3.47 mm	3.5 mm	1.5mm	1.10 mm	5699BB 126	8.47 mm	8.5 mm	5.0mm	6.50 mm
5699BB 314	3.47 mm	3.5 mm	1.5mm	1.20 mm					
5699BB 315	3.47 mm	3.5 mm	1.5mm	1.30 mm					
5699BB 316	3.47 mm	3.5 mm	1.5mm	1.40 mm					
5699BB 15	3.47 mm	3.5 mm	1.5mm	1.50 mm					
5699BB 49	3.47 mm	3.5 mm	1.5mm	1.60 mm					
5699BB 17	3.47 mm	3.5 mm	1.5mm	1.75 mm					

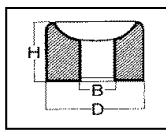

Bergeon Bronze Bushing System

Bushing Number	Reamer Number	"D" Out Side Diameter	"H" Height	"B" Inside Diameter	Bushing Number	Reamer Number	"D" Out Side Diameter	"H" Height	"B" Inside Diameter
4165A/ 1	1.97 mm	2.0 mm	1.5mm	0.40 mm	4165A/ 31	1.97 mm	2.0 mm	1.5mm	0.30 mm
4165A/ 2	1.97 mm	2.0 mm	1.5mm	0.50 mm	4165A/ 32	1.97 mm	2.0 mm	1.5mm	0.35 mm
4165A/ 3	1.97 mm	2.0 mm	1.5mm	0.60 mm	4165A/ 33	1.97 mm	2.0 mm	2.0mm	0.40 mm
4165A/ 4	1.97 mm	2.0 mm	3.0mm	0.60 mm	4165A/ 34	1.97 mm	2.0 mm	2.0mm	0.45 mm
4165A/ 5	1.97 mm	2.0 mm	1.5mm	0.70 mm	4165A/ 35	1.97 mm	2.0 mm	1.2mm	0.50 mm
4165A/ 6	1.97 mm	2.0 mm	3.0mm	0.70 mm	4165A/ 36	1.97 mm	2.0 mm	2.0mm	0.50 mm
4165A/ 7	2.47 mm	2.5 mm	1.5mm	0.80 mm	4165A/ 37	1.97 mm	2.0 mm	1.5mm	0.55 mm
4165A/ 8	2.47 mm	2.5 mm	3.0mm	0.80 mm	4165A/ 38	1.97 mm	2.0 mm	2.0mm	0.65 mm
4165A/ 9	2.47 mm	2.5 mm	1.5mm	0.90 mm	4165A/ 39	1.97 mm	2.0 mm	2.0mm	0.75 mm
4165A/ 10	2.47 mm	2.5 mm	3.0mm	0.90 mm	4165A/ 40	2.47 mm	2.5 mm	2.0mm	0.85 mm
4165A/ 11	2.97 mm	3.0 mm	1.5mm	1.00 mm	4165A/ 41	2.47 mm	2.5 mm	1.2mm	0.95 mm
4165A/ 12	2.97 mm	3.0 mm	3.0mm	1.00 mm	4165A/ 42	2.97 mm	3.0 mm	2.0mm	1.00 mm
4165A/ 13	2.97 mm	3.0 mm	1.5mm	1.25 mm	4165A/ 43	2.97 mm	3.0 mm	2.0mm	1.10 mm
4165A/ 14	2.97 mm	3.0 mm	3.0mm	1.25 mm	4165A/ 44	2.97 mm	3.0 mm	2.0mm	1.20 mm
4165A/ 15	3.47 mm	3.5 mm	1.5mm	1.50 mm	4165A/ 45	2.97 mm	3.0 mm	2.0mm	1.25 mm
4165A/ 16	3.47 mm	3.5 mm	3.0mm	1.50 mm	4165A/ 46	2.97 mm	3.0 mm	2.0mm	1.30 mm
4165A/ 17	3.47 mm	3.5 mm	1.5mm	1.75 mm	4165A/ 47	3.47 mm	3.5 mm	2.0mm	1.40 mm
4165A/ 18	3.47 mm	3.5 mm	3.0mm	1.75 mm	4165A/ 48	3.47 mm	3.5 mm	2.0mm	1.50 mm
4165A/ 19	4.47 mm	4.5 mm	1.5mm	2.00 mm	4165A/ 49	3.47 mm	3.5 mm	3.0mm	1.60 mm
4165A/ 20	4.47 mm	4.5 mm	3.0mm	2.00 mm	4165A/ 50	3.47 mm	3.5 mm	3.0mm	1.65 mm
4165A/ 21	4.47 mm	4.5 mm	1.5mm	2.25 mm	4165A/ 51	3.47 mm	3.5 mm	2.0mm	1.70 mm
4165A/ 22	4.47 mm	4.5 mm	3.0mm	2.25 mm	4165A/ 52	3.47 mm	3.5 mm	2.0mm	1.80 mm
4165A/ 23	4.47 mm	4.5 mm	1.5mm	2.50 mm	4165A/ 53	3.47 mm	3.5 mm	2.0mm	1.90 mm
4165A/ 24	4.47 mm	4.5 mm	3.0mm	2.50 mm	4165A/ 54	4.47 mm	4.5 mm	2.0mm	2.00 mm
4165A/ 25	5.47 mm	5.5 mm	1.5mm	3.00 mm	4165A/ 55	4.47 mm	4.5 mm	2.0mm	2.10 mm
4165A/ 26	5.47 mm	5.5 mm	3.0mm	3.00 mm	4165A/ 56	4.47 mm	4.5 mm	2.0mm	2.25 mm
4165A/ 27	6.47 mm	6.5 mm	1.5mm	4.00 mm	4165A/ 57	4.47 mm	4.5 mm	2.0mm	2.40 mm
4165A/ 28	6.47 mm	6.5 mm	3.0mm	4.00 mm	4165A/ 58	4.47 mm	4.5 mm	2.0mm	2.75 mm
4165A/ 29	7.47 mm	7.5 mm	3.0mm	5.00 mm	4165A/ 59	8.47 mm	8.5 mm	2.0mm	5.00 mm
4165A/ 30	8.47 mm	8.5 mm	3.0mm	6.00 mm	4165A/ 60	8.47 mm	8.5 mm	2.0mm	6.50 mm

Bergeon Bronze Bushing: pkg of 10 pc. & 100 pc.

Order No. 4165A/ No. for pkg. of 10 pc.

Order No. 4165A/1 No. for pkg. of 100 pc.

No.2,3,5,6,7,8,9,10,11,12,13,14,38,39,40,41,42,43,44,45,46

Per Pkg. of 10 pc.

Per Pkg of 100 pc.

1 to 5 pkg. \$ 5.25 pkg.

1 to 5 pkg. \$ 30.25 pkg.

6 pkg & up .. \$ 5.00 pkg.

6 pkg. & up ... \$ 30.00 pkg.

No. 1,4, 31,32,33,34,35,36,37

1 to 5 pkg.\$ 5.00 pkg.

1 to 5 pkg. \$ 30.50 pkg.

6 pkg. & up \$ 4.75 pkg.

6 pkg. & up ... \$ 30.25 pkg.

No.15,16,17,18,19,20,21,22,23,24,25,26,47,48,49,50,51,52,53,54,55,56,57,58

1 to 5 pkg. \$ 5.50 pkg.

1 to 5 pkg. \$ 34.25 pkg.

6 pkg. & up\$ 5.25 pkg.

6 pkg. & up \$ 34.00 pkg

No. 27,28

1 to 5 pkg.\$ 10.25 pkg.

1 to 5 pkg. \$ 69.25 pkg.

6 pkg. & up ... \$ 10.00 pkg.

6 pkg. & up ... \$ 69.00 pkg.

No. 29,30,59,60

1 to 5 pkg. \$ 15.50 pkg.

1 to 5 pkg. \$ 113.50 pkg.

6 pkg. & up ... \$ 15.25 pkg.

6 pkg. & up ... \$ 113.25 pkg.

Kieninger Winding Arbor Bushing

For KSU & RSU Movements

All Bushing are 22 mm Outside Diameter.



80.202
6.5 mm ID.
Front Bushing
\$ 3.75 ea.



80.203
5.5 mm ID.
Front Bushing
\$ 8.00 ea.



80.201
3.0 mm ID
Rear Bushing
\$ 3.75 ea.



80.204
Bushing Screws
6 Pieces per Pkg.
\$ 3.25 pkg.

Prices Subject To Change Without Notice.

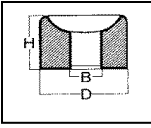

“NEW” American Made Bergeon Bronze Bushing System

American Made Bergeon Bronze Bushing comes in packages of 20 pieces.

4165BZ/1-24,31-58,101-110,301-335 \$ 5.25 pkg. 6 to 11 pkg. \$ 5.00 pkg. 12 and up \$ 4.75 pkg.

4165BZ/25-30, 59,60,123,126 \$ 7.50 pkg. 6 to 11 pkg. \$ 7.25 pkg. 12 and up \$ 7.00 pkg.

Bushing Number	Reamer Number	“D” OutSide Diameter	“H” Height	“B”Inside Diameter	Bushing Number	Reamer Number	“D”Out Side Diameter	“H” Height	“B”Inside Diameter
4165BZ 35	1.97 mm	2.0 mm	1.2mm	0.50 mm	4165BZ 317	3.47 mm	3.5 mm	1.5mm	1.80 mm
4165BZ 31	1.97 mm	2.0 mm	1.5mm	0.30 mm	4165BZ 318	3.47 mm	3.5 mm	1.5mm	1.90 mm
4165BZ 32	1.97 mm	2.0 mm	1.5mm	0.35 mm	4165BZ 337	3.47 mm	3.5 mm	2.0mm	1.00 mm
4165BZ 01	1.97 mm	2.0 mm	1.5mm	0.40 mm	4165BZ 338	3.47 mm	3.5 mm	2.0mm	1.10 mm
4165BZ 02	1.97 mm	2.0 mm	1.5mm	0.50 mm	4165BZ 320	3.47 mm	3.5 mm	2.0mm	1.20 mm
4165BZ 37	1.97 mm	2.0 mm	1.5mm	0.55 mm	4165BZ 321	3.47 mm	3.5 mm	2.0mm	1.30 mm
4165BZ 03	1.97 mm	2.0 mm	1.5mm	0.60 mm	4165BZ 47	3.47 mm	3.5 mm	2.0mm	1.40 mm
4165BZ 05	1.97 mm	2.0 mm	1.5mm	0.70 mm	4165BZ 48	3.47 mm	3.5 mm	2.0mm	1.50 mm
4165BZ 301	1.97 mm	2.0 mm	1.5mm	0.95 mm	4165BZ 50	3.47 mm	3.5 mm	2.0mm	1.65 mm
4165BZ 341	1.97 mm	2.0 mm	2.0mm	0.30 mm	4165BZ 51	3.47 mm	3.5 mm	2.0mm	1.70 mm
4165BZ 33	1.97 mm	2.0 mm	2.0mm	0.40 mm	4165BZ 52	3.47 mm	3.5 mm	2.0mm	1.80 mm
4165BZ 34	1.97 mm	2.0 mm	2.0mm	0.45 mm	4165BZ 53	3.47 mm	3.5 mm	2.0mm	1.90 mm
4165BZ 36	1.97 mm	2.0 mm	2.0mm	0.50 mm	4165BZ 339	3.47 mm	3.5 mm	3.0mm	1.00 mm
4165BZ 38	1.97 mm	2.0 mm	2.0mm	0.65 mm	4165BZ 340	3.47 mm	3.5 mm	3.0mm	1.10 mm
4165BZ 39	1.97 mm	2.0 mm	2.0mm	0.75 mm	4165BZ 323	3.47 mm	3.5 mm	3.0mm	1.20 mm
4165BZ 0	1.97 mm	2.0 mm	2.6mm	0.30 mm	4165BZ 324	3.47 mm	3.5 mm	3.0mm	1.30 mm
4165BZ 00	1.97 mm	2.0 mm	2.6mm	0.40 mm	4165BZ 325	3.47 mm	3.5 mm	3.0mm	1.40 mm
4165BZ 304	1.97 mm	2.0 mm	3.0mm	0.40 mm	4165BZ 16	3.47 mm	3.5 mm	3.0mm	1.50 mm
4165BZ 305	1.97 mm	2.0 mm	3.0mm	0.50 mm	4165BZ 326	3.47 mm	3.5 mm	3.0mm	1.60 mm
4165BZ 04	1.97 mm	2.0 mm	3.0mm	0.60 mm	4165BZ 18	3.47 mm	3.5 mm	3.0mm	1.75 mm
4165BZ 06	1.97 mm	2.0 mm	3.0mm	0.70 mm	4165BZ 327	3.47 mm	3.5 mm	3.0mm	1.80 mm
4165BZ 101	1.97 mm	2.0 mm	5.0mm	0.80 mm	4165BZ 328	3.47 mm	3.5 mm	3.0mm	1.90 mm
4165BZ 102	1.97 mm	2.0 mm	5.0mm	1.00 mm	4165BZ 330	4.47 mm	4.5 mm	1.5mm	1.90 mm
4165BZ 07	2.47 mm	2.5 mm	1.5mm	0.80 mm	4165BZ 19	4.47 mm	4.5 mm	1.5mm	2.00 mm
4165BZ 09	2.47 mm	2.5 mm	1.5mm	0.90 mm	4165BZ 21	4.47 mm	4.5 mm	1.5mm	2.25 mm
4165BZ 41	2.47 mm	2.5 mm	2.0mm	0.80 mm	4165BZ 23	4.47 mm	4.5 mm	1.5mm	2.50 mm
4165BZ 40	2.47 mm	2.5 mm	2.0mm	0.85 mm	4165BZ 332	4.47 mm	4.5 mm	2.0mm	1.90 mm
4165BZ 308	2.47 mm	2.5 mm	2.0mm	0.90 mm	4165BZ 54	4.47 mm	4.5 mm	2.0mm	2.00 mm
4165BZ 08	2.47 mm	2.5 mm	3.0mm	0.80 mm	4165BZ 55	4.47 mm	4.5 mm	2.0mm	2.10 mm
4165BZ 10	2.47 mm	2.5 mm	3.0mm	0.90 mm	4165BZ 56	4.47 mm	4.5 mm	2.0mm	2.25 mm
4165BZ 103	2.47 mm	2.5 mm	5.0mm	1.00 mm	4165BZ 57	4.47 mm	4.5 mm	2.0mm	2.40 mm
4165BZ 104	2.47 mm	2.5 mm	5.0mm	1.20 mm	4165BZ 333	4.47 mm	4.5 mm	2.0mm	2.50 mm
4165BZ 106	2.47 mm	2.5 mm	5.0mm	1.40 mm	4165BZ 58	4.47 mm	4.5 mm	2.0mm	2.75 mm
4165BZ 109	2.47 mm	2.5 mm	5.0mm	1.05 mm	4165BZ 335	4.47 mm	4.5 mm	3.0mm	1.90 mm
4165BZ 11	2.97 mm	3.0 mm	1.5mm	1.00 mm	4165BZ 20	4.47 mm	4.5 mm	3.0mm	2.00 mm
4165BZ 13	2.97 mm	3.0 mm	1.5mm	1.25 mm	4165BZ 22	4.47 mm	4.5 mm	3.0mm	2.25 mm
4165BZ 42	2.97 mm	3.0 mm	2.0mm	1.00 mm	4165BZ 24	4.47 mm	4.5 mm	3.0mm	2.50 mm
4165BZ 43	2.97 mm	3.0 mm	2.0mm	1.10 mm	4165BZ 121	4.47 mm	4.5 mm	5.0mm	3.00 mm
4165BZ 44	2.97 mm	3.0 mm	2.0mm	1.20 mm	4165BZ 25	5.47 mm	5.5 mm	1.5mm	3.00 mm
4165BZ 45	2.97 mm	3.0 mm	2.0mm	1.25 mm	4165BZ 26	5.47 mm	5.5 mm	3.0mm	3.00 mm
4165BZ 46	2.97 mm	3.0 mm	2.0mm	1.30 mm	4165BZ 27	6.47 mm	6.5 mm	1.5mm	4.00 mm
4165BZ 12	2.97 mm	3.0 mm	3.0mm	1.00 mm	4165BZ 28	6.47 mm	6.5 mm	3.0mm	4.00 mm
4165BZ 14	2.97 mm	3.0 mm	3.0mm	1.25 mm	4165BZ 123	6.47 mm	6.5 mm	5.0mm	4.50 mm
4165BZ 105	2.97 mm	3.0 mm	5.0mm	1.20 mm	4165BZ 29	7.47 mm	7.5 mm	3.0mm	5.00 mm
4165BZ 107	2.97 mm	3.0 mm	5.0mm	1.40 mm	4165BZ 59	8.47 mm	8.5 mm	2.0mm	5.00 mm
4165BZ 108	2.97 mm	3.0 mm	5.0mm	1.60 mm	4165BZ 60	8.47 mm	8.5 mm	2.0mm	6.50 mm
4165BZ 110	2.97 mm	3.0 mm	5.0mm	1.80 mm	4165BZ 30	8.47 mm	8.5 mm	3.0mm	6.00 mm
4165BZ 336	3.47 mm	3.5 mm	1.5mm	1.10 mm	4165BZ 126	8.47 mm	8.5 mm	5.0mm	6.50 mm
4165BZ 314	3.47 mm	3.5 mm	1.5mm	1.20 mm					
4165BZ 315	3.47 mm	3.5 mm	1.5mm	1.30 mm					
4165BZ 316	3.47 mm	3.5 mm	1.5mm	1.40 mm					
4165BZ 15	3.47 mm	3.5 mm	1.5mm	1.50 mm					
4165BZ 49	3.47 mm	3.5 mm	1.5mm	1.60 mm					
4165BZ 17	3.47 mm	3.5 mm	1.5mm	1.75 mm					

AMERICAN SYSTEM BUSHING BRASS

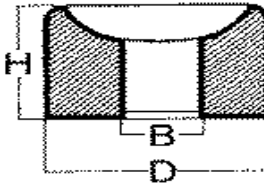
D	DIA	HEIGHT		HEIGHT					
		B	I.D.	1.4 mm	1.9 mm				
1.80	R	0.3	SB72.064	64					
	E	0.4	SB72.008	08	21900B	*			
	A	0.5	SB72.009	09	SB72.032	32			
	M	0.6	SB72.010	10	SB72.033	33			
	E	0.7	SB72.011	11	SB72.034	34			
	R	0.8	SB72.012	12	SB72.035	35			
	# 2	0.9	SB72.013	13	SB72.036	36	HEIGHT	HEIGHT	
	1.78	1.0	SB72.065	65	SB72.037	37	2.7 mm	3.5 mm	
							22700B	*	
							32700B	*	33500B
2.70	R	1.0	SB72.014	14					
	E	1.1	SB72.015	15	SB72.038	38	SB72.100	100	33511
	A	1.2	SB72.016	16	SB72.039	39	SB72.101	101	33512
	M	1.3	SB72.017	17	SB72.040	40	SB72.102	102	33513
	E	1.4	SB72.018	18	SB72.041	41	SB72.103	103	33514
	R	1.5	SB72.019	19	SB72.042	42	SB72.104	104	33515
	# 3	1.6	SB72.020	20	SB72.043	43	SB72.105	105	33516
	2.68	1.7	SB72.067	67	SB72.088	88	SB72.106	106	33517
		1.8	SB72.021	21	SB72.044	44	SB72.107	107	33518
		1.9	SB72.068	68	SB72.089	89	SB72.108	108	33519
3.50					41900B	*	42700B	*	43500B
	# 4	2.0	SB72.022	22	SB72.045	45	SB72.109	109	43520
	3.48	2.1	SB72.069	69	SB72.090	90	SB72.110	110	43521
		2.2	SB72.023	23	SB72.046	46	SB72.111	111	43522
		2.3	SB72.070	70	SB72.091	91	SB72.112	112	43523
		2.4	SB72.024	24	SB72.047	47	SB72.113	113	43524
		2.5	SB72.071	71	SB72.092	92	SB72.114	114	43525
		2.6	SB72.025	25	SB72.048	48	SB72.115	115	43526
		2.7	SB72.072	72	SB72.093	93	SB72.116	116	43527
						** Indicates Extra Long 5.5 mm Length			45500B
5.90					51900B	*	52700B	*	
	# 5	3.0			SB72.050	50	SB72.118	118	
	5.85	3.2			SB72.051	51	SB72.119	119	
		3.4			SB72.081	81	SB72.120	120	
		3.6			SB72.052	52	SB72.121	121	
		4.0			SB72.083	83	SB72.123	123	
		4.4			SB72.084	84	SB72.125	125	
		4.8			SB72.085	85	SB72.127	127	
8.70	# 6	4.0 mm Height							
	8.64	5.0	SB72.128	128					
		5.4	SB72.130	130	* Indicates Blank Bushing (Not Drilled)				
		5.8	SB72.132	132	Back Winding Arbor Bushing for Herschede Front Winding Arbor Bushing for Herschede				
		6.2	SB72.134	134					
		6.6	SB72.136	136					

ORDER NO. SB72. Pkg. NO. (Like 1 pkg. of no 45 SB72.045)
 Pkg of 20 pc. No SB72.008 to 048, SB72.064 to 072, SB72.088 to116 & 22700 Thru 45550
 1 to 5 \$ 7.50 pkg.
 6 to 11 \$ 7.25 pkg.
 12 and up \$ 7.00 pkg.

ORDER NO. SB50/72. Pkg. NO. (Like 1 pkg. of no 45 SB50/72.045)
 Pkg of 50 pc. No SB50/72.008 to 048, SB50/72.064 to 072, SB50/72.088 to116
 1 to 5 Pkg. \$ 16.00 ea. ... 6 to 11Pkg. \$ 15.75 ea. ... 12 & up ... \$ 15.50 ea.
 Pkg. of 25 pc. No. SB72.050 to 052, SB72.081 to 085,SB72.118 to127 &51900 & 52700
 1 to 9 \$ 14.00 pkg.
 10 and up \$ 13.75 pkg.

Pkg. of 10 pc. No. SB72.128 Thru SB72.136
 1 to 9 \$ 11.50 pkg.
 10 and up \$ 11.25 pkg.

Price Subject To Change without notice.

AMERICAN SYSTEM BUSHING ASSORTMENT

Contains 100 Bushing 10 of ea. Size.



ASSORTMENT # 1

This Assortment contains all 1.4 mm height Bushing . Nos. 14, 15, 16, 17, 18, 19, 20, 21, 67, 68
 72.301 \$ 38.00

ASSORTMENT # 2

This Assortment contains all 1.9 mm Height Bushing. Nos. 37, 38, 39, 40, 41, 42, 43, 44, 88, 89
 72.302 \$ 38.00

ASSORTMENT # 3

This Assortment contains all 2.7 mm Height Bushing Nos. 100, 101, 102, 103, 104, 105, 106, 107, 108, 109
 72.303 \$ 38.00

ASSORTMENT # 4

This Assortment contains all 2.7 mm Height Bushing Nos. 107, 108, 109, 110, 111, 112, 113, 114, 115, 116
 72.304 \$ 38.00

ASSORTMENT # 5

This Assortment contains all 3.5 mm Height Bushing Nos. 33511, 33512, 33513, 33514, 33515, 33516, 33517 33518, 33519, 33520
 72.305 \$ 38.00

ASSORTMENT # 6

This Assortment contains all 3.5 mm Height Bushing Nos. 33518, 33519 33520, 33521, 33522, 33523, 33524 33525, 33526, 33527
 72.306 \$ 38.00

REPLACEMENT REAMERS

American Made KWM Reamers

Part No.	Reamer #	Reamer size
24.415	I	1.18 mm or .047"
24.416	II	1.78 mm or .070"
24.417	III	2.69 mm or .105"
24.418	IV	3.48 mm or .137"
24.420	V	5.85 mm or .231"
		\$ 16.00 ea. 3 or more \$ 15.75 ea.
24.421	VI	8.64 mm or .341"
		\$ 17.50 ea.

HANDLE ONLY



Handle only for American made style KWM Reamers. Length 4-1/2" long.

24.561 \$ 14.00 ea.

Complete Table of KWM Bronze Friction Bushing (American Made)

Order Number for bushing is SBB72.B57 Sample of the part Number KWM Bronze Bushing Refills Pkg. 20 pc.
 SBB72. 01-026,032-049,055-072,086-117,138-147 \$ 5.25 Pkg. ... 6 to 11 \$ 5.00 Pkg. ... 12 or More \$ 4.75 Pkg.
 SBB72.27-31,50-54,73-85,118-137 \$ 7.50 Pkg. ... 6 to 11 \$ 7.25 Pkg. ... 12 or More \$ 7.00 Pkg.

Z Pivot Diameter	B o r e	H D R I N	1.0		1.4					1.7	1.9			2.7					3.0	4.0
			1.2	1.8	1.8	2.7	3.5	4.7	5.9	5.9	1.8	2.7	3.5	1.8	2.7	3.5	4.7	5.9	8.7	8.7
			1.18	1.78	1.78	2.68	3.48	4.66	5.85	5.85	1.78	2.68	3.48	1.78	2.68	3.48	4.66	5.85	8.64	8.64
			II	II	II	III	IV	IVa	V	V	II	III	IV	II	III	IV	IVa	V	VI	VI
0.07-0.08	0.1		B55																	
0.10-0.12	0.15		B56																	
0.15-0.17	0.2		B01																	
0.19-0.21	0.25		B57																	
0.23-0.25	0.3		B02		B64						B86									
0.27-0.30	0.35		B58																	
0.32-0.35	0.4		B03		B08						B87									
0.38-0.40	0.45		B59																	
0.42-0.45	0.5		B04		B09						B32			B94						
0.48-0.50	0.55		B60																	
0.53-0.55	0.6		B05		B10						B33			B95						
0.57-0.60	0.7		B06		B11						B34			B96						
0.65-0.70	0.8		B07		B12						B35			B97						
0.75-0.80	0.9			B61	B13						B36			B98						
0.85-0.90	1.0			B62	B65	B14					B37				B99					
0.95-1.00	1.1			B63	B66	B15							B38		B100					
1.05-1.10	1.2					B16							B39		B101					
1.15-1.20	1.3					B17							B40		B102					
1.25-1.30	1.4					B18							B41		B103					
1.35-1.40	1.5					B19							B42		B104					
1.45-1.50	1.6					B20							B43		B105					
1.55-1.60	1.7					B67							B88		B106					
1.65-1.70	1.8					B21							B44		B107					
1.75-1.80	1.9					B68							B89		B108					
1.85-1.90	2.0						B22							B45		B109				
1.95-2.00	2.1						B69							B90		B110				
2.05-2.10	2.2						B23							B46		B111				
2.15-2.20	2.3						B70							B91		B112				
2.25-2.30	2.4						B24							B47		B113				
2.35-2.40	2.5						B71							B92		B114				
2.45-2.50	2.6						B25							B48		B115				
2.55-2.60	2.7						B72							B93		B116				
2.65-2.70	2.8						B26			B79				B49		B117				
2.75-2.80	2.9							B138	B73	B80							B143			
2.85-2.90	3.0							B139	B27	B50							B144	B118		
2.95-3.05	3.2							B140	B28	B51							B145	B119		
3.10-3.25	3.4							B141	B74	B81							B146	B120		
3.30-3.45	3.6							B142	B29	B52							B147	B121		
3.55-3.65	3.8								B75	B82								B122		
3.75-3.85	4.0								B76	B83								B123		
3.90-4.05	4.2								B30	B53								B124		
4.15-4.25	4.4								B77	B84								B125		
4.35-4.45	4.6								B31	B54								B126		
4.55-4.65	4.8								B78	B85								B127		
4.75-4.85	5.0																		B128	
5.00-5.05	5.2																		B129	
5.15-5.25	5.4																		B130	
5.35-5.45	5.6																		B131	
5.55-5.65	5.8																		B132	
5.75-5.85	6.0																		B133	
5.95-6.05	6.2																			B134
6.15-6.25	6.4																			B135
6.35-6.45	6.6																			B136
6.55-6.65	6.8																			B137

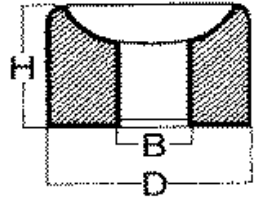

How to use this chart
 The numbers prefixed by the letter "B" such as B57 in the chart Indicates the bushing number.
 The number serves as a refill number for various assortments.
 To select the correct bushing, first Measure the pivot, & find it size in the range of sizes shown in column Z. By reading across, you Will find the various bushing that Will fit the size pivot.
 Select the thickness of bushing by Referring to letter "H" & the correct diameter by the letter "D".
 After choosing the bushing, read Up the column to line "RN" which indicates the size reamer to Be used for the selected bushing.
 Reamers are identified by Roman numerals.

Prices Subject To Change Without Notice.

Complete Table of KWM Brass Friction Bushing (German Made)

KWM Brass Bushing Refills..... Pkg. 20 pc. Sizes 72.001 to 72.127, and 72.138 to 72.147 ... 1 to 11 pkg. \$ 9.75 pkg.
 12 pkg. or more \$ 9.50 pkg. Sizes 72.128 to 72.137 pkg of 10 pc. 1 to 11 \$ 16.50 pkg. 12 pkg or more \$ 16.25 pkg.

Z Pivot Diameter	B o r e	H D R R N	1.0		1.4					1.7	1.9			2.7					3.0	4.0	
			1.2	1.8	1.8	2.7	3.5	4.7	5.9	5.9	1.8	2.7	3.5	1.8	2.7	3.5	4.7	5.9	8.7	8.7	
			1.18	1.78	1.78	2.68	3.48	4.66	5.85	5.85	1.78	2.68	3.48	1.78	2.68	3.48	4.66	5.85	8.64	8.64	
			I	II	II	III	IV	IVa	V	V	II	III	IV	II	III	IV	IVa	V	VI	VI	
0.07-0.08	0.1		L55																		
0.10-0.12	0.15		L56																		
0.15-0.17	0.2		L01																		
0.19-0.21	0.25		L57																		
0.23-0.25	0.3		L02		L64					L86											
0.27-0.30	0.35		L58																		
0.32-0.35	0.4		L03		L08					L87											
0.38-0.40	0.45		L59																		
0.42-0.45	0.5		L04		L09					L32				L94							
0.48-0.50	0.55		L60																		
0.53-0.55	0.6		L05		L10					L33				L95							
0.57-0.60	0.7		L06		L11					L34				L96							
0.65-0.70	0.8		L07		L12					L35				L97							
0.75-0.80	0.9			L61	L13					L36				L98							
0.85-0.90	1.0			L62	L65	L14				L37				L99							
0.95-1.00	1.1			L63	L66	L15					L38			L100							
1.05-1.10	1.2					L16					L39			L101							
1.15-1.20	1.3					L17					L40			L102							
1.25-1.30	1.4					L18					L41			L103							
1.35-1.40	1.5					L19					L42			L104							
1.45-1.50	1.6					L20					L43			L105							
1.55-1.60	1.7					L67					L88			L106							
1.65-1.70	1.8					L21					L44			L107							
1.75-1.80	1.9					L68					L89			L108							
1.85-1.90	2.0						L22					L45		L109							
1.95-2.00	2.1						L69					L90		L110							
2.05-2.10	2.2						L23					L46		L111							
2.15-2.20	2.3						L70					L91		L112							
2.25-2.30	2.4						L24					L47		L113							
2.35-2.40	2.5						L71					L92		L114							
2.45-2.50	2.6						L25					L48		L115							
2.55-2.60	2.7						L72					L93		L116							
2.65-2.70	2.8						L26		L79			L49		L117							
2.75-2.80	2.9							L138	L73	L80							L143				
2.85-2.90	3.0							L139	L27	L50							L144	L118			
2.95-3.05	3.2							L140	L28	L51							L145	L119			
3.10-3.25	3.4							L141	L74	L81							L146	L120			
3.30-3.45	3.6							L142	L29	L52							L147	L121			
3.55-3.65	3.8								L75	L82								L122			
3.75-3.85	4.0								L76	L83								L123			
3.90-4.05	4.2								L30	L53								L124			
4.15-4.25	4.4								L77	L84								L125			
4.35-4.45	4.6								L31	L54								L126			
4.55-4.65	4.8								L78	L85								L127			
4.75-4.85	5.0																			L128	
5.00-5.05	5.2																			L129	
5.15-5.25	5.4																			L130	
5.35-5.45	5.6																			L131	
5.55-5.65	5.8																			L132	
5.75-5.85	6.0																			L133	
5.95-6.05	6.2																				L134
6.15-6.25	6.4																				L135
6.35-6.45	6.6																				L136
6.55-6.65	6.8																				L137

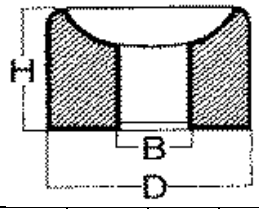

How to use this chart
 The numbers prefixed by the letter "L" such as L57 in the chart Indicates the bushing number. The number serves as a refill number for various assortments. To select the correct bushing, first Measure the pivot, & find it size in the range of sizes shown in column Z. By reading across, you Will find the various bushing that Will fit the size pivot. Select the thickness of bushing by Referring to letter "H" & the correct diameter by the letter "D". After choosing the bushing, read Up the column to line "RN" which indicates the size reamer to Be used for the selected bushing. Reamers are identified by Roman numerals.

Prices Subject To Change Without Notice.

**American Made
KWM Bronze, Bergeon Brass
& Bergeon Bronze Bushing
Assortment**

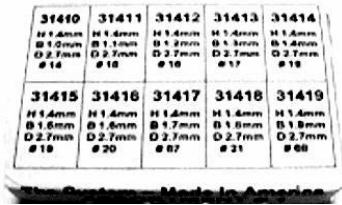

**10 each of 10 different sizes
100 Bushing per Assortment.
\$ 27.25 ea. ... 2 & up \$ 27.00 ea.**

**American Made
KWM Bronze Bushing
Assortment Number 1**

Bushing are 1.4 mm High
Take A # 3 Reamer

Order Number will be SBB72. Number

Part #	OD mm	Height mm	ID mm
14	2.70	1.40	1.00
15	2.70	1.40	1.10
16	2.70	1.40	1.20
17	2.70	1.40	1.30
18	2.70	1.40	1.40
19	2.70	1.40	1.50
20	2.70	1.40	1.60
67	2.70	1.40	1.70
21	2.70	1.40	1.80
68	2.70	1.40	1.90

72.307 ... Bronze Bushing Assortment

Assortment Number 2

Bushing are 1.8 mm & 2.7 mm High
Takes A # 2 & # 3 Reamer

Order Number will be SBB72. Number

Part #	OD mm	Height mm	ID mm
37	1.80	1.90	1.00
38	2.70	1.90	1.10
39	2.70	1.90	1.20
40	2.70	1.90	1.30
41	2.70	1.90	1.40
42	2.70	1.90	1.50
43	2.70	1.90	1.60
88	2.70	1.90	1.70
44	2.70	1.90	1.80
89	2.70	1.90	1.90

72.308 ... Bronze Bushing Assortment

WINDING ARBOR BUSHING



72.501

6.30 mm OD.

5.30 mm ID.

3.25 mm High



72.502

6.30 mm OD

4.80 mm ID

6.25mm high

72.501 ... Time 3 to a pkg. ... \$ 2.25 pkg.

72.502 ... Strike 3 to a pkg. ... \$ 2.25 pkg.

**American Made
Bergeon Brass And Bronze
Bushing Assortment**

Assortment Number 1

For Small Bores Bushing are 1.5 mm High

Takes A # 1.97, # 2.47 & # 2.97 Reamer

Order Number Brass 5699BB/ Number

Order Number Bronze 4165BZ/ Number

Part #	OD mm	Height mm	ID mm
31	2.00	1.50	0.30
01	2.00	1.50	0.40
02	2.00	1.50	0.50
03	2.00	1.50	0.60
05	2.00	1.50	0.70
301	2.00	1.50	0.95
07	2.50	1.50	0.80
09	2.50	1.50	0.90
11	3.00	1.50	1.00
13	3.00	1.50	1.25

72.315 ... Brass Bushing Assortment

72.309 ... Bronze Bushing Assortment

Assortment Number 2

For Medium/Large Bores

Bushing are 1.5 mm High

Takes A # 3.47, & # 4.47 Reamer

Order Number Brass 5699BB/ Number

Order Number Bronze 4165BZ/ Number

Part #	OD mm	Height mm	ID mm
315	3.50	1.50	1.30
316	3.50	1.50	1.40
15	3.50	1.50	1.50
49	3.50	1.50	1.60
17	3.50	1.50	1.75
317	3.50	1.50	0.80
318	3.50	1.50	1.90
19	4.50	1.50	2.00
21	4.50	1.50	2.25
23	4.50	1.50	2.50

72.316 ... Brass Bushing Assortment

72.310 ... Bronze Bushing Assortment

Assortment Number 3

For Small Bores Bushing are 2.0 mm High

Takes A # 1.97, # 2.47 & # 2.97 Reamer

Order Number Brass 5699BB/ Number

Order Number Bronze 4165BZ/ Number

Part #	OD mm	Height mm	ID mm
33	2.00	2.00	0.40
36	2.00	2.00	0.50
38	2.00	2.00	0.65
39	2.00	2.00	0.75
41	2.50	2.00	0.80
308	2.50	2.00	0.90
42	3.00	2.00	1.00
43	3.00	2.00	1.10
44	3.00	2.00	1.20
46	3.00	2.00	1.30

72.317 ... Brass Bushing Assortment

72.311 ... Bronze Bushing Assortment

Assortment Number 4

For Medium/Large Bores

Bushing are 2.0 mm High

Takes A # 3.47, & # 4.47 Reamer

Order Number Brass 5699BB/ Number

Order Number Bronze 4165BZ/ Number

Part #	OD mm	Height mm	ID mm
47	3.50	2.00	1.40
48	3.50	2.00	1.50
50	3.50	2.00	1.65
51	3.50	2.00	1.70
52	3.50	2.00	1.80
53	3.50	2.00	1.90
54	4.50	2.00	2.00
55	4.50	2.00	2.10
56	4.50	2.00	2.25
57	4.50	2.00	2.40

72.318 ... Brass Bushing Assortment

72.312 ... Bronze Bushing Assortment

Assortment Number 5

For Small Bores Bushing are 3.0 mm High

Takes A #1.97, #2.47, # 2.97, #3.47 Reamer

Order Number Brass 5699BB/ Number

Order Number Bronze 4165BZ/ Number

Part #	OD mm	Height mm	ID mm
304	2.00	3.00	0.40
305	2.00	3.00	0.50
04	2.00	3.00	0.60
06	2.00	3.00	0.70
08	2.50	3.00	0.80
10	2.50	3.00	0.90
12	3.00	3.00	1.00
14	3.00	3.00	1.25
323	3.50	3.00	1.20
324	3.50	3.00	1.30

72.319 ... Brass Bushing Assortment

72.313 ... Bronze Bushing Assortment

Assortment Number 6

Bushing are 3.0 mm High

Takes A # 3.47, & # 4.47 Reamer

Order Number Brass 5699BB/ Number

Order Number Bronze 4165BZ/ Number

Part #	OD mm	Height mm	ID mm
325	3.50	3.00	1.40
16	3.50	3.00	1.50
326	3.50	3.00	1.60
18	3.50	3.00	1.75
327	3.50	3.00	1.80
328	3.50	3.00	1.90
335	4.50	3.00	1.90
20	4.50	3.00	2.00
22	4.50	3.00	2.25
24	4.50	3.00	2.50

72.320 ... Brass Bushing Assortment

72.314 ... Bronze Bushing Assortment

**Other Bushing Assortment on
Page 43**

Prices subject To Change Without Notice.

WINDING ARBOR BUSHING



9.8 mm OD. 9.8 mm OD. 0.8 mm OD. 11.8 mm OD
4.0 mm ID. 7.8 mm ID. 7.8 mm ID. 7.8 mm ID.

1 of Each Size ... 4 pieces to a package
72.500 \$ 2.50 pkg.

Winding Arbor Bushing Assortment



Winding Arbor Bushing Assortment
12 pieces 2 of 6 sizes.

6 mm OD X 3 mm ID
7 mm OD X 3.5 mm ID
8 mm OD X 4 mm ID
9 mm OD X 4.5 mm ID
10 mm OD X 5 mm ID
11 mm OD X 5 mm ID
72.503 \$ 7.00 pkg.

Storage Boxes

Wood Storage Box



Wooden storage box 9-1/2" X 5-1/4". The box has 36 aluminum can with clear tops. Can size is 7/8" dia. X 3/4" deep.
90.100 \$ 20.00 each.
3 or more \$ 19.50 each.

Aluminum Storage Boxes

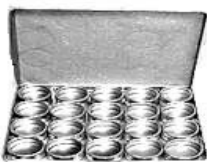

Aluminum Storage Box 6-3/4" X 5-1/2" Box has 20 containers.
With Clear or Color lids. Containers size 1-1/4" dia. X 3/4" deep.
90.101 ... Clear Lids \$ 8.50 ea.
3 or more \$ 8.25 ea.
90.104 ... Color Lids \$ 8.50 ea.
3 or more \$ 8.25 ea.

Wood Box For Bushing



Hardwood box with a sliding top can be used to keep Bushing in And other items. Box is 7-1/2" L X 4-3/4" W X 1" D. Has 60 holes.
90.106 \$ 27.50 ea.

Plastic Storage Boxes



Small plastic storage boxes for small Parts to keep from getting lost.
Box size 1-1/8" X 1-1/8" X 3/4" Deep
15.129 \$ 1.00 ea.
12 or more \$ 0.85 ea
Box size 2" X 2" X 3/4" Deep
15.132 \$ 1.25 ea.
12 or more \$ 1.00 ea

Mainspring Barrel Bushing Adaptor

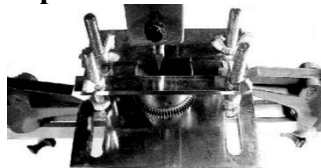

Clamp to hold Mainspring barrel to install bushing in barrel. Can be used on Bushing tool or Drill press bushing tool.
24.550 \$ 25.00

Drill Press Bushing Tool



Designed for your drill press. Includes two plate clamps with floating heads to prevent damage to soft brass clock plates, horizontal slide, mounting bolts, reamer adaptor, centering point and anvils. Reamers not included. Uses American/KWM or Bergeon reamers.
24.575 \$ 162.50

Bergeon Drill Press Adaptor



Bergeon reamer adaptor for using on drill Press to install Bushing. Comes with a Allen wrench. Adaptor is 2" long.
24.570 \$ 8.00 ea.

Prices Subject To Change Without Notice.

KWM Drill Press Adaptor



KWM reamer adaptor for using on drill Press to install Bushing.
Adaptor is 2" Long
24.571 \$ 8.00 ea.

KWM & Bergeon Drill Press Adaptor



One drill press adaptor for both Bushing set up.
24.569 \$ 10.50 ea

Clamp On Bushing Tool

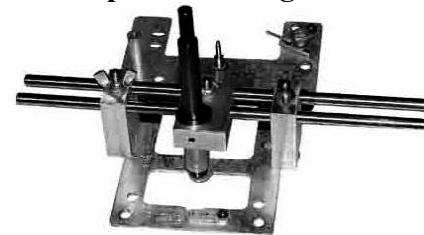

Clamp on bushing tool can be used on Clocks plates by disassembling the clock Movement and clamping this bushing Tool on the plate. You can use it for KWM Or Bergeon Bushing Systems. Comes with Hex wrench and reamer adaptor.
24.576 KWM set up \$ 145.00
24.577 Bergeon set up \$ 145.00
24.578 KWM Adaptor \$ 12.00
24.579 Bergeon Adaptor \$ 12.00

Bushing Tool Jig



Made of Brass. This tool can be used when Bushing the escape wheel bridge on the The front plate, it will help support the bridge while reaming and putting in the bushing. The jig has 5 heights.
12.320 \$ 9.50

Digital Caliper 6"

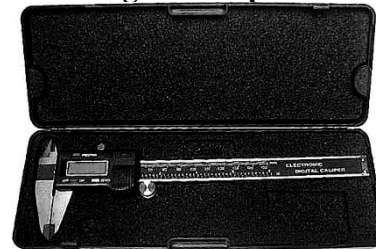

Digital Caliper 6" long Stainless Steel. Measure in INCHES or MM.
35.180 \$ 27.50 ea.
35.181 ... Replacement Battery \$ 2.00

HAND BUSHING TOOL



Hand bushing tool for KWM & System Bushing. Contains 1 Handle, 5 Reamers & 1 Chamfering cutter. Good for the person just starting out in clock repairing.

24.560 \$ 93.50

HANDLE ONLY



Handle only for American made style KWM Reamers. Length 4-1/2" long.

24.561 \$ 14.00 ea.



REPLACEMENT REAMERS

American Made KWM Reamers

Part No.	Reamer #	Reamer size
24.415	I	1.18 mm or .047"
24.416	II	1.78 mm or .070"
24.417	III	2.69 mm or .105"
24.418	IV	3.48 mm or .137"
24.420	V	5.85 mm or .231"
\$ 16.00 ea. 3 or more \$ 15.75 ea.		
24.421	VI	8.64 mm or .341"
\$ 17.50 ea.		

Bergeon Reamers for KWM & American System KWM & KWM German Style Bushing.
Reamer is KWM front Bergeon Back End.



Part No.	Reamer #	Reamer size
24.422	I	1.18 mm or .047"
24.423	II	1.78 mm or .070"
24.424	III	2.69 mm or .105"
24.425	IV	3.48 mm or .137"
24.426	V	5.85 mm or .231"
\$ 16.00 ea. 3 or more 15.75 ea.		
24.427	VI	8.64 mm or .341"
\$ 17.50 ea.		

Bergeon Pivot Cutters-Swiss Made



pivot Dia. Cutter Dia. Price

6200/26	... 40 mm - 2.20 mm	... \$48.50 ea.
6200/27	... 70 mm - 3.00 mm	... \$48.50 ea.
6200/28	... 1.50 mm - 5.00 mm	... \$48.50 ea.
6200/29	... 3.00 mm - 6.00 mm	... \$48.50 ea.
6200/30	... 5.00 mm - 9.00 mm	... \$50.50 ea.



BERGEON REAMERS (Swiss Made)

Replacement Reamers for Bergeon Bushing

6200/14	1.20 mm
6200/15	1.97 mm
6200/16	2.47 mm
6200/17	2.97 mm
6200/18	3.47 mm
6200/19	4.47 mm
6200/20	5.47 mm
6200/21	6.47 mm
6200/22	7.47 mm
6200/23	8.47 mm
\$ 22.50 ea. 3 or more \$ 22.25 ea.		
6200/25	.. chamfering cutter 10 mm
\$ 25.75 ea.		



BERGEON REAMERS (USA Made)

Replacement Reamers for Bergeon Bushing

6200/15 A	1.97 mm
6200/16 A	2.47 mm
6200/17 A	2.97 mm
6200/18 A	3.47 mm
6200/19 A	4.47 mm
\$ 16.00 ea. 3 and Up \$ 15.75 ea.		

KWM Reamers for Bergeon American Made & Bergeon Style Bushing. Reamer Bergeon Front end KWM back End.



Part No.	Reamer #	Reamer size
24.428	1.97 mm
24.429	2.47 mm
24.430	2.97 mm
24.431	3.47 mm
24.432	4.47 mm
\$ 16.00 ea. 3 or more 15.75 ea.		

KWM Reamers (German)



24.419 is IVa Reamer 4.66mm
24.419G \$ 41.50

KWM Bushing and Pivot Gauge

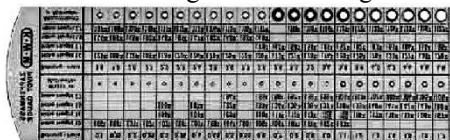

24.540 138.50

KWM Center, Pushers & Chamfer

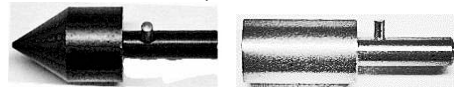

KWM Center 3 sizes KWM Pusher

24.437 Center \$ 7.50
24.438	... # 1 Small Pusher \$ 7.50
24.439	... # 2 Medium Pusher \$ 7.50
24.440	... # 3 Large Pusher \$ 7.50



24.435 ... Small Chamfer ... \$ 7.50
24.436 ... Large Chamfer ... \$ 7.50

Bergeon Center, Pushers & Chamfer



Bergeon Center 3 sizes Bergeon Pusher

24.441 Center \$ 7.50
24.444	... # 1 Small Pusher \$ 7.50
24.445	... # 2 Medium Pusher \$ 7.50
24.446	... # 3 Large Pusher \$ 7.50



24.442 ... Small Chamfer ... \$ 7.50
24.443 ... Large Chamfer ... \$ 7.50

Hand Bushing Set Up Bergeon



Hand bushing tool for Bergeon Bushing System. Contains 1 Handle, 5 Reamers & 1 Chamfering cutter. Good for the person just starting out in clock repairing.

24.562 \$ 77.50 set

Handle Only Bergeon Hand Reamer



24.563 \$ 12.00

Clock Staking Set

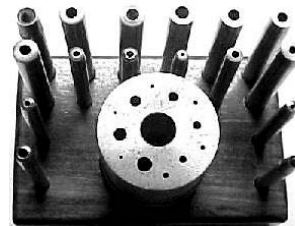

Clock maker punch and staking set. Comes With 16 Punches and a anvil in wood stand
25.710 \$ 58.75 set

Prices Subject To Change Without Notice.

KEYSTONE

UNIVERSAL BUSHING MACHINE

And CLOCK STAKING TOOL

MANUFACTURED BY CRAFTSMEN FOR CRAFTSMEN WITH PRIDE

For holding, centering & reaming
clock & instrument plates
for bushing

Model UBM-87

Heavy, rugged construction of extremely durable alloys. Built for years of hard use. Net weight 18 lbs.

UBM-87 comes with adapter for either KWM or Bergeon style reamers. Your choice.

Finished with durable powder coating. Far superior and longer lasting than painted, enameled or anodized finishes. Your bushing machine will look great for years to come.

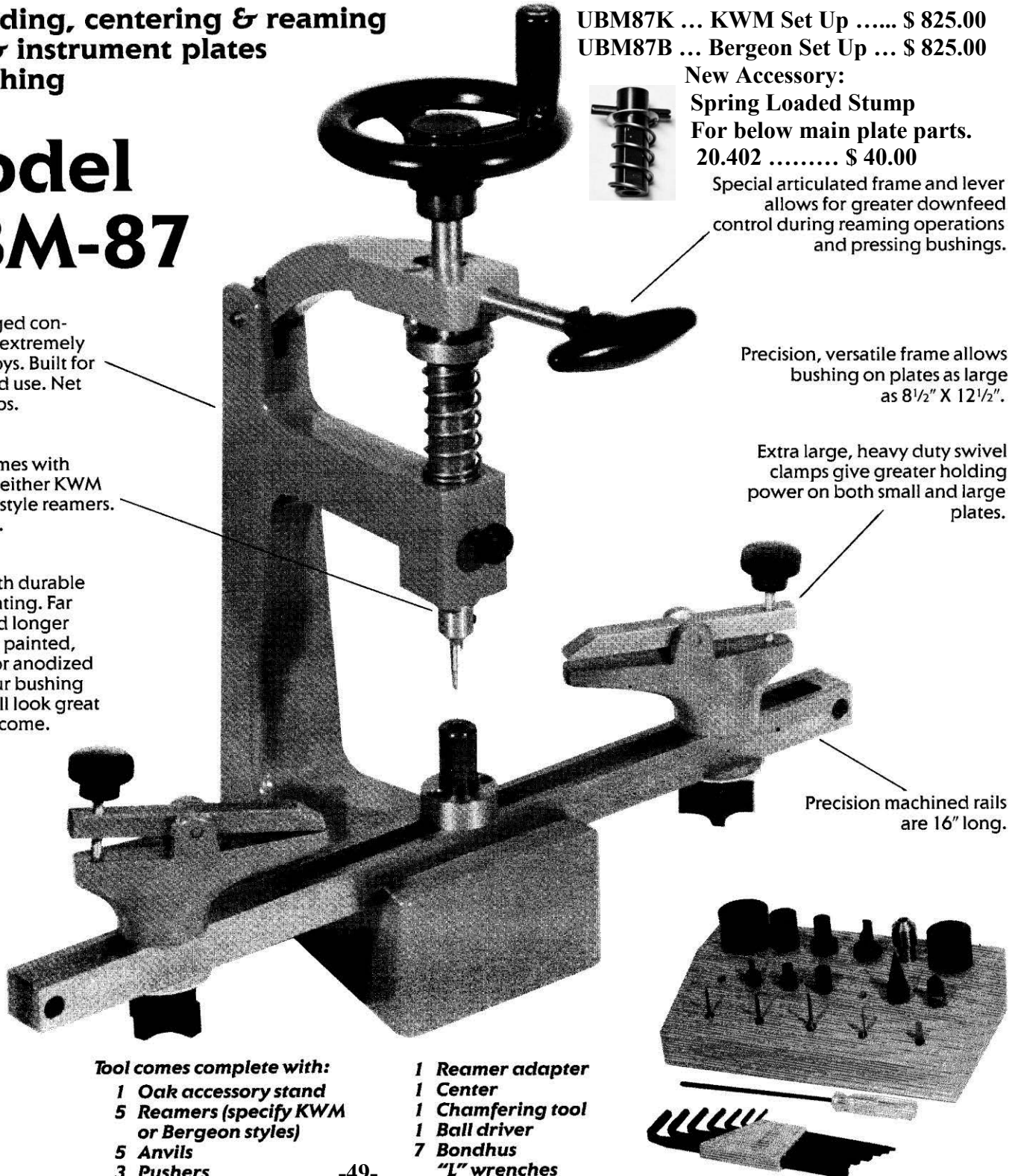

UBM87K ... KWM Set Up \$ 825.00

UBM87B ... Bergeon Set Up ... \$ 825.00

New Accessory:

Spring Loaded Stump

For below main plate parts.

20.402 \$ 40.00

Special articulated frame and lever allows for greater downfeed control during reaming operations and pressing bushings.

Precision, versatile frame allows bushing on plates as large as 8 1/2" X 12 1/2".

Extra large, heavy duty swivel clamps give greater holding power on both small and large plates.

Precision machined rails are 16" long.

Tool comes complete with:

- 1 Oak accessory stand
- 5 Reamers (specify KWM or Bergeon styles)
- 5 Anvils
- 3 Pushers

- 1 Reamer adapter
- 1 Center
- 1 Chamfering tool
- 1 Ball driver
- 7 Bondhus "L" wrenches

**TWIST DRILL SET
61 TO 80 TWIST DRILL SET**



High speed twist drill set Sizes 61 to 80
In plastic stand.
28.502 \$ 24.50 set

**High Speed Twist Drills Replacement
French Made Drills**

- 28.530 NO. 30
- 28.531 NO. 31
- 28.532 NO. 32
- 28.533 NO. 33
- 28.534 NO. 34
- 28.535 NO. 35
- 28.536 NO. 36
- 28.537 NO. 37
- 28.538 NO. 38
- 28.539 NO. 39
- 28.540 NO. 40
- 28.541 NO. 41
- 28.542 NO. 42
- 28.543 NO. 43
- 28.544 NO. 44
- 28.545 NO. 45
- 28.546 NO. 46
- 28.547 NO. 47
- 28.548 NO. 48
- 28.549 NO. 49
- 28.550 NO. 50
- 28.551 NO. 51
- 28.552 NO. 52
- 28.553 NO. 53
- 28.554 NO. 54
- 28.555 NO. 55
- 28.556 NO. 56
- 28.557 NO. 57
- 28.558 NO. 58
- 28.559 NO. 59
- 28.560 NO. 60
- 28.561 NO. 61
- 28.562 NO. 62
- 28.563 NO. 63
- 28.564 NO. 64
- 28.565 NO. 65
- 28.566 NO. 66
- 28.567 NO. 67
- 28.568 NO. 68
- 28.569 NO. 69
- 28.570 NO. 70

\$ 2.50 ea ... 6 or more \$ 2.25 ea

- 28.571 NO. 71
- 28.572 NO. 72
- 28.573 NO. 73
- 28.574 NO. 74
- 28.575 NO. 75
- 28.576 NO. 76
- 28.577 NO. 77

\$ 3.25 ea ... 6 or more \$ 3.00 ea

Prices Subject To Change Without Notice.

High Speed Twist Drills

- 28.578 NO. 78
 - 28.579 NO. 79
 - 28.580 NO. 80
- \$ 4.00 ea ... 6 or more \$ 3.75 ea

CARBIDE DRILLS

1/8" SHAFT, SIZES IN "MM"



- CD050 0.50 mm
 - CD060 0.60 mm
 - CD070 0.70 mm
 - CD080 0.80 mm
 - CD090 0.90 mm
 - CD100 1.00 mm
 - CD110 1.10 mm
 - CD120 1.20 mm
 - CD140 1.40 mm
 - CD160 1.60 mm
 - CD180 1.80 mm
 - CD200 2.00 mm
- \$ 6.75 ea 6 and up \$ 6.50 ea

Drill Set 61 to 80 French Made



Dormer High Speed twist drill set of 20 sizes.
Set sizes 61 to 80. Comes in a selector case
With slide cover to select only the size you
Need. Sizes are noted right on the case.
Drills can easily be replaced so the set is
always in order and protected.
28.0540 \$ 55.75 set.

**HIGH SPEED STEEL TWIST
DRILLS IN WOOD STAND**

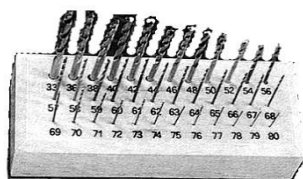

German Made
Set of 36 High Speed Steel Twist Drill
Sizes # 33 to # 80
28.504 \$ 49.75 set.

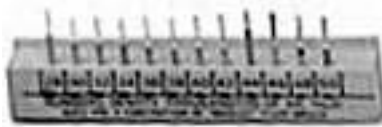

Flat Pivot Drill Sets

Drills are made of carbon steel. The flat
Pivot drill makes for perfect centering.
Set comes in wood block with 12 assorted
Sizes.
28.350 (three each) .004" to .010" \$ 50.50
28.351 (one each) .004" to .026" \$ 52.50
28.352 (one each) .028" to .050" \$ 50.00

Replacement Flat Pivot Drills

Shank for sizes .004" to .026" is 1 mm

- 28.364004" \$ 4.50 each
- 28.366006" \$ 4.50 each
- 28.368008" \$ 4.50 each
- 28.370010" \$ 4.50 each
- 28.372012" \$ 4.50 each
- 28.374014" \$ 4.50 each
- 28.376016" \$ 4.50 each
- 28.378018" \$ 4.50 each
- 28.380020" \$ 4.50 each
- 28.382022" \$ 4.50 each
- 28.384024" \$ 4.50 each
- 28.386026" \$ 4.50 each

Shank for sizes .028" to .050" is 1.5 mm

- 28.388028" \$ 4.50 each
- 28.390030" \$ 4.50 each
- 28.392032" \$ 4.50 each
- 28.394034" \$ 4.50 each
- 28.396036" \$ 4.50 each
- 28.398038" \$ 4.50 each
- 28.400040" \$ 4.50 each
- 28.402042" \$ 4.50 each
- 28.404044" \$ 4.50 each
- 28.406046" \$ 4.50 each
- 28.408048" \$ 4.50 each
- 28.410050" \$ 4.50 each

PIN VICES



DOUBLE-ENDED PIN VICE

With reversable steel collets in each end.
Hexagonal head prevent rolling. Hollow
handle and head made of Brass. Capacity
is 0 to .125" (0 to 3.0 mm), overall
length 4-1/8".
58.240 \$ 4.75

SQUARE CHUCK PIN VICE



Has two steel chucks with spare chuck
held in end of hollow brass handle.
Capacity 0 to .079" , Overall length 3-1/8"
58.250 \$ 7.75 ea.

Pin Vice



Swivel Head Pin Vice. 3-1/2" Long
Capacity ... 0" to .125" (0-3.2 mm)
58.221 \$ 4.50 ea.



Slip Ring Pin vice 0-0.8mm (0-0.32")
4-1/2" Long
58.300 \$ 4.25 ea.

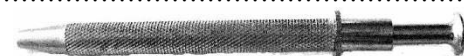

Prong holding Tweezers with 4 Prongs
57.635 5" Long \$ 2.50

SCREWDRIVER SETS

Made In France

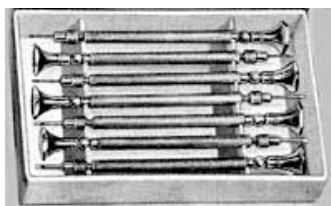

Set of seven, numbers 3 through 9 in box. Reversible, double-ended blades with threaded ferrules. Nickel plated to prevent rust. Color coded heads for quick selection.

52.730 \$ 26.50 SET.

REPLACEMENT BLADES

Replacement Blades for set 52.730

52.735/3 ...Orange058" ... 1.50 mm
 52.735/4 ...Black050" ... 1.28 mm
 52.735/5 ...Green047" ... 1.20 mm
 52.735/6 ...Brown039" ... 1.00 mm
 52.735/7 ...Red033"80 mm
 52.735/8 ...Silver027"70 mm
 52.735/9 ...Blue060"60 mm
 1 pkg. Of 3 blades \$ 1.75 pkg.
 3 pkg. Or more of 3 blades \$ 1.50 pkg.

SCREWDRIVER SET



6 pc. Precision Screwdriver Set

The screwdriver shafts are molybdenum steel, hardened and chrome plated for strength and torque. The six tools come with precision ground tips in 4 flat head sizes (1.5 x 50 mm, 2 x 50 mm, 2.5 x 50 mm & 3 x 50 mm) 2 Phillips head sizes (.00 x 50 mm & 0 x 50 mm)
 52.850 \$ 21.50 set

NUT DRIVER SET



10 piece Nut Driver Set; This set has 10 color - coded nutdrivers in sizes; 3/32" 1/8", 5/32", 3/16", 7/32", 1/4", 9/32", 5/16", 11/32", and 3/8". The torque handle measures 1" X 3-1/8".

52.888 \$ 64.75 set.

SCREWDRIVER SET IN STAND



Precision-made with set screws in side to hold blade firmly. Each handle color banded for size.Length range from 4-1/8" to 3-1/4". Contains all 9 blade sizes. 3.00 mm to .60 mm. Center of stand has compartments for separate blades.

52.540 \$ 58.75 set

REPLACEMENT BLADES



52.560 ... Brown118" ... 3.00 mm
 52.561 ... Blue089" ... 2.50 mm
 52.562 ... Green078" ... 2.00 mm
 52.563 ... Purple065" ... 1.60 mm
 52.564 ... Gray055" ... 1.40 mm
 52.565 ... Red047" ... 1.20 mm
 52.566 ... Black039" ... 1.00 mm
 52.567 ... Yellow031" ... 0.80 mm
 52.568 ... Lilac023" ... 0.60 mm

1 pkg of 3 blades \$2.50 pkg.
 3 pkg. of 3 blades or more \$ 2.25 pkg.

REPLACEMENT SCREWDRIVERS



52.550 ... Brown118" ... 3.00 mm
 52.551 ... Blue089" ... 2.50 mm
 52.552 ... Green078" ... 2.00 mm
 52.553 ... Purple065" ... 1.60 mm
 52.554 ... Gray055" ... 1.40 mm
 52.555 ... Red047" ... 1.20 mm
 52.556 ... Black039" ... 1.00 mm
 52.557 ... Yellow031" ... 0.80 mm
 52.558 ... Lilac023" ... 0.60 mm
 \$ 4.50 each 3 or more \$ 4.25 each

QUICK-WEDGE SCREW HOLDER SCREWDRIVERS



52.862 .. 1/8" blade 5" overall length.
 52.866 .. 1/8" blade 10" overall length.
 52.868 .. Bevel blade ... 10" overall length.
 52.870 .. 3/16" blade ... 6" overall length.
 52.862 \$ 9.25 ea.
 52.866 \$ 10.00 ea.
 52.868 \$ 9.75 ea.
 52.870 \$ 10.00 ea.

Price subject to change without notice.

-51-

Center Punch



Slim design for better visibility. Can be adjusted for light or heavy stroke.
 47.860 \$ 21.50



Carbide Tip Waller Scribe
 52.950 \$ 9.50

SET OF 20 PIN PUNCHES W/ Adjustable Brass Holder

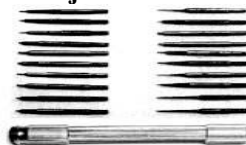

Set contains two each of 10 difference size hardened steel punches. Flat tips range from .020" to .050" in diameter and are easily ground to make other sizes. Punches are 1-5/8" long, with a 3/32" Shank. Used to drive out pins, broken Screws, riveting, etc.Brass holder 3-1/4" Long.

47.890 \$ 62.00 set



FOUR PIECE PIN VICE SET

Hardened steel pin vices ensure long life. Set of four with sizes range of 0 to 3/16". Comes in a Handy plastic pouch.

58.286 \$ 12.50 set.

SCREWDRIVER SHARPENER



Spring action holds screwdriver firmly in place. Steel wheels are carefully set into body to provide even action when wheeled over stone. Overall width is 1-9/16. Stone and screwdriver shown for Illustration purposes only.

52.469 \$ 13.00 ea.

CROCKER PATTERN



GRAVER SHARPENER

Graver can be set to any angle by setting index. Holds graver edge in position while honing on oilstone.

36.880 \$ 52.50

BROACHES ENGLISH PATTERN BROACHES

Cutting, cleaning and finishing broaches made of high quality steel and uniformly tempered for long life. The lengths vary from approximately 1 3/4" (44 mm) to over 7" (178mm), with diameters gauged slightly below largest portion of the cutting edges.

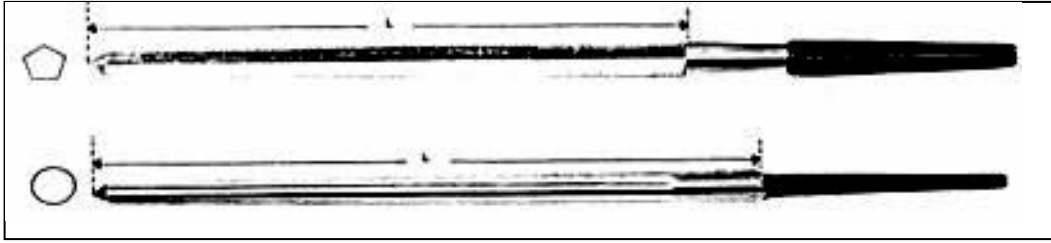

**FIVE-SIDED CUTTING
BROACHES**

**ROUND SMOOTHING
BROACHES**

CUTTING

PART NO.	STUBB SIZE	DIA. MM	PRICE
BR 59.260	"Z"	10.49	\$ 45.00
BR 59.220	"U"	9.25	\$ 34.75
BR 59.190	"S"	8.89	\$ 29.50
BR 59.160	"P"	8.20	\$ 25.25
BR 59.140	"N"	7.67	\$ 21.50
BR 59.120	"L"	7.37	\$ 21.50
BR 59.090	"I"	6.91	\$ 17.50
BR 59.070	"H"	6.60	\$ 18.50
BR 59.030	"C"	6.15	\$ 17.00
BR 15.301	1	5.76	\$ 11.25
BR 15.305	5	5.18	\$ 10.00
BR 15.310	10	4.92	\$ 9.50
BR 15.315	15	4.57	\$ 8.50
BR 15.320	20	4.09	\$ 7.25
BR 15.325	25	3.76	\$ 6.75
BR 15.330	30	3.23	\$ 6.00
BR 15.335	35	2.74	\$ 4.50
BR 15.340	40	2.46	\$ 4.00
BR 15.345	45	2.06	\$ 3.25
BR 15.348	48	1.90	\$ 3.25
BR 15.350	50	1.75	\$ 2.75
BR 15.351	51	1.70	\$ 2.75
BR 15.352	52	1.60	\$ 2.75
BR 15.354	54	1.40	\$ 2.75
BR 15.355	55	1.27	\$ 2.75
BR 15.358	58	1.04	\$ 2.75
BR 15.360	60	.99	\$ 2.50
BR 15.362	62	.94	\$ 2.50
BR 15.365	65	.84	\$ 2.50
BR 15.368	68	.81	\$ 2.50
BR 15.370	70	.68	\$ 2.50
BR 15.372	72	.61	\$ 2.50
BR 15.375	75	.51	\$ 2.50
BR 15.380	80	.31	\$ 2.50

Prices Subject To Change Without Notice.

SMOOTHING

PART NO.	STUBB SIZE	DIA. MM	PRICE
BR 49.019	"S"	8.89	\$ 31.50
BR 49.013	"M"	7.49	\$ 24.25
BR 49.008	"J"	7.05	\$ 20.25
BR 49.007	"G"	6.63	\$ 17.50
BR 49.006	4	5.25	\$ 13.75
BR 15.422	22	3.81	\$ 10.75
BR 15.438	38	2.56	\$ 6.00
BR 15.446	48	1.90	\$ 5.00
BR 15.454	54	1.40	\$ 4.20
BR 15.460	60	1.00	\$ 3.90
BR 15.466	66	.81	\$ 3.90
BR 15.472	72	.61	\$ 3.00
BR 15.478	78	.38	\$ 3.00

SET of BERGEON BROACHES with KNURLED HANDLES, CUTTING AND SMOOTHING.

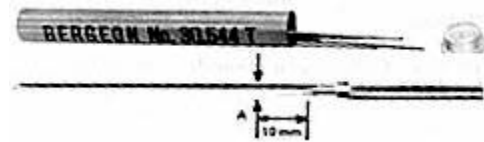

Made of the finest alloy steel, highly ground and polished. Sets contain seven of the most frequently used sizes from Stubs 28 to 70. Handles are made of PVC so no pinvice is required.
 64.30543T Smoothing Broaches \$ 62.00
 64.30544T Cutting Broaches \$ 62.00

ENGLISH PATTERN BROACHES

Cutting, cleaning and finishing broaches made of high quality steel and uniformly tempered for long life. The lengths vary from approximately 1-3/4" to over 7", with diameters gauged slightly below largest portion of the cutting edges.

Set of 12 Cutting Broaches with a stub



Size of 15-70. 12 of the most used sizes.
 15.500 \$ 38.75

Set of 12 smoothing Broaches, sizes 15-70 stub size.
 15.513 \$ 38.75

PIKE SWISS BRAND SAW BLADES

SEE FOR YOURSELF THEIRS:

Manufactured by the standard MILLING PROCESS

The economical **Milling Process** leaves Massive burs on one side of the teeth Which prevents the blade from sawing Straight. The space between the teeth is Often not equal, thereby producing Inconsistent cuts.



OURS:

Manufactured by our precision FILING PROCESS

By contrast, we manufacture our saw blade With Swiss filing to produce teeth that are Perfectly sharpened and have a consistent Point to the tooth. Our precision **FILING PROCESS** of manufacturing results in Superior saw blades to cut Easier, faster, straighter and Cleaner every time.



JEWELERS PIERCING SAW BLADES

Made in Switzerland, these are the finest Jewelers saw blades available. Manufactured To exacting tolerances for angle, size and cut of each tooth.

Each tooth is a **Filing Process** not **Milling Process**.

For cutting all metals and other materials.

Featuring:

Our unique tempering process which ensures consistent **flexibility** and long blade life and gives our saw blades their exclusive gold straw color. This golden straw color is your guarantee of receiving the world's finest saw blades.

Rounded back makes cutting curves easier.

PIKE SAW BLADES

Teeth

Part No.	Size	per in.	Per Doz	Per gross
49.440	8/0	84	\$ 4.25	\$ 46.00
49.441	7/0	84	\$ 4.00	\$ 42.50
49.442	6/0	76	\$ 3.75	\$ 39.75
49.443	5/0	66	\$ 3.25	\$ 35.50
49.444	4/0	64	\$ 3.00	\$ 32.25
49.445	3/0	57	\$ 2.75	\$ 29.50
49.446	2/0	53	\$ 2.75	\$ 29.50
49.447	1/0	51	\$ 2.75	\$ 29.50
49.448	1	47	\$ 2.75	\$ 29.50
49.450	2	44	\$ 2.75	\$ 29.50
49.451	3	40	\$ 2.75	\$ 29.50
49.452	4	37	\$ 2.85	\$ 30.50
49.453	5	35	\$ 3.00	\$ 32.25
49.454	6	33	\$ 3.25	\$ 35.50
49.456	8	28	\$ 3.75	\$ 40.50
49.458	10	24	\$ 5.50	\$ 59.75
49.460	12	20	\$ 6.40	\$ 68.75
49.462	14	16	\$ 7.55	\$ 82.00

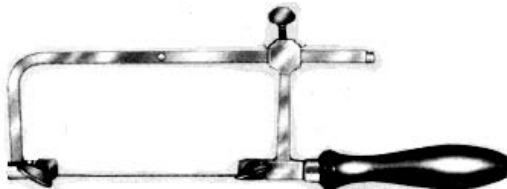

SAW FRAMES

STANDARD JEWELERS SAWFRAME

Made in Germany. For use with piercing, flat and spiral sawblades. Serrated clamps hold blades firmly. Stongly constructed with flat steel frame, hardwood handle and thumb screw locking device.

49.704 4" saw frame \$ 17.50

SWISS-MADE SAWFRAME

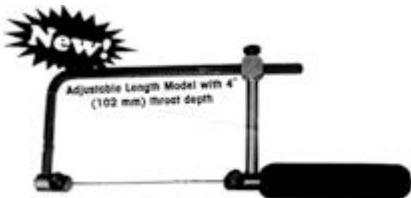

Revolutionary design, perfectly balanced sawframe. Patented blade-lock design-maintain perfect alignment and reduces blade loss.

Adjustable frame made in Switzerland, of high quality spring steel. Set screws can be used on either left or right side of frame.

49.720 2 3/4 Deep Saw Frame \$ 15.75

49.724 4" Deep Saw Frame \$ 17.75

Prices Subject To Change Without Notice.



UNIVERSAL PIVOT FILE / BURNISHER

Regular burnishers are polished and have slight rounded corners Swiss Quality.

31.01710 RH  \$ 97.50

31.01720 LH  \$ 97.50

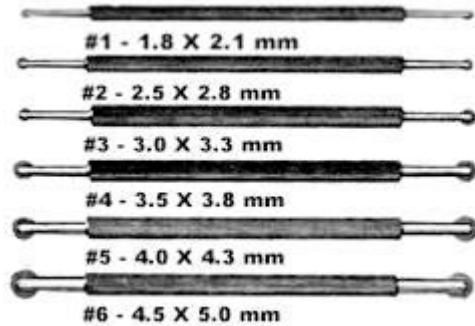

COUNTERSINK & BURNISHER SET

For removing burs, burnishing holes after drilling and reaming, and countersinking tapered sholders screws. Set contains six double-ended knurled handles with wheels in diameters of 1.8 mm to 5.0 mm.

BS 59.0130 \$ 87.50



BRASS AND STEEL WOOD SCREWS



Flat Head

RH is Round Head Screws
FH is Flat Head Screws

Round Head

Pkg. 50 pc. Brass

75.300 ... # 0 X 1/4 RH ... \$ 2.50 ea.
75.301 ... # 0 X 1/4 FH ... \$ 2.50 ea.
75.310 ... # 1 X 1/4 FH ... \$ 2.50 ea.
75.311 ... # 1 X 1/4 RH ... \$ 2.50 ea.
75.312 ... # 1 X 3/8 RH ... \$ 2.50 ea.
75.313 ... # 1 X 3/8 FH ... \$ 2.50 ea.
75.320 ... # 2 X 1/4 RH ... \$ 2.50 ea.
75.321 ... # 2 X 1/4 FH ... \$ 2.50 ea.
75.322 ... # 2 X 3/8 RH ... \$ 2.50 ea.
75.323 ... # 2 X 3/8 FH ... \$ 2.50 ea.
75.324 ... # 2 X 1/2 RH ... \$ 2.75 ea.
75.325 ... # 2 X 1/2 FH ... \$ 2.75 ea.
75.326 ... # 2 X 5/8 FH ... \$ 2.75 ea.
75.327 ... # 2 X 3/4 FH ... \$ 2.75 ea.

Pkg. 50 pc. Brass

75.330 ... # 3 X 1/4 RH ... \$ 2.75 ea.
75.331 ... # 3 X 1/4 FH ... \$ 2.75 ea.
75.332 ... # 3 X 3/8 RH ... \$ 2.75 ea.
75.333 ... # 3 X 3/8 FH ... \$ 2.75 ea.
75.334 ... # 3 X 1/2 RH ... \$ 2.70 ea.
75.335 ... # 3 X 1/2 FH ... \$ 2.70 ea.
75.336 ... # 3 X 5/8 RH ... \$ 3.25 ea.
75.337 ... # 3 X 3/4 FH ... \$ 3.25 ea.
75.340 ... # 4 X 1/4 FH ... \$ 3.25 ea.
75.349 ... # 4 X 1/4 RH ... \$ 3.25 ea.
75.341 ... # 4 X 3/8 RH ... \$ 3.25 ea.
75.342 ... # 4 X 3/8 FH ... \$ 3.25 ea.
75.343 ... # 4 X 1/2 RH ... \$ 3.25 ea.
75.345 ... # 4 X 1/2 FH ... \$ 3.25 ea.
75.346 ... # 4 X 5/8 FH ... \$ 3.25 ea.
75.347 ... # 4 X 3/4 FH ... \$ 3.25 ea.
75.348 ... # 4 X 1 FH ... \$ 4.00 ea.

Pkg. 50 pc. Brass

75.350 ... # 5 X 3/8 FH ... \$ 4.00 ea.
75.351 ... # 5 X 3/8 RH ... \$ 4.00 ea.
75.352 ... # 5 X 1/2 RH ... \$ 4.00 ea.
75.353 ... # 5 X 1/2 FH ... \$ 4.00 ea.
75.354 ... # 5 X 5/8 FH ... \$ 4.00 ea.
75.355 ... # 5 X 3/4 FH ... \$ 4.00 ea.
75.356 ... # 5 X 1 FH ... \$ 5.00 ea.
75.360 ... # 6 X 3/8 RH ... \$ 5.00 ea.
75.361 ... # 6 X 3/8 FH ... \$ 5.00 ea.
75.362 ... # 6 X 1/2 FH ... \$ 5.00 ea.
75.363 ... # 6 X 1/2 RH ... \$ 5.00 ea.
75.364 ... # 6 X 5/8 FH ... \$ 5.25 ea.
75.365 ... # 6 X 3/4 FH ... \$ 5.25 ea.
75.366 ... # 6 X 1 FH ... \$ 5.50 ea.

Pkg. 50 pc. Steel Wood Screws

75.375 ... # 6 X 1/2 FH ... \$ 4.50 ea.
75.380 ... # 8 X 3/8 FH ... \$ 4.50 ea.
75.390 ... # 10 X 3/8 FH ... \$ 4.50 ea.
75.391 ... # 10 X 5/8 FH ... \$ 5.00 ea.

SWISS SCREW ASSORTMENT



Bergeon Brass and Steel Screw Assortment 150 pc. Screws for Clocks.
30.478 \$ 32.75 ea.



BRASS Rivet Assortment 100 pc.
10.014 \$ 7.00

BERGEON ASSORTMENT OF TAPER Pins Brass And Steel Assortment Contains 500 pc.



30486 STEEL \$ 75.75 ea.
30487 BRASS \$ 75.75 ea.

ASSORTMENTS OF TAPERED PINS



AMERICAN MADE TAPERED PINS
100 PC. OF 4 SIZES 1" BRASS
76600 \$ 12.00 pkg.
100 PC. OF 4 SIZES 1" STEEL
76601 \$ 12.00 pkg.

BRASS AND STEEL TAPER PINS

ROUND BRASS TAPERED PINS



1" LONG BRASS AND STEEL AMERICAN MADE TAPERED PINS
50 pc in a pkg.
TPB001 BRASS015" to .050"
TPB002 BRASS030" to .065"
TPB003 BRASS045" to .080"
TPB004 BRASS060" to .095"
TPS001 STEEL015" to .050"
TPS002 STEEL030" to .065"
TPS003 STEEL045" to .080"
TPS004 STEEL060" to .080"
50 pc.to a pkg.
\$ 4.50 ea. 6 pkg. And up \$ 4.25 ea.

Taper pins .600" long



American made 50 pc.in package.
76.611010" X .026" ... Brass
76.612024" X .040" ... Brass
76.613034" X .050" ... Brass
76.614044" X .060" ... Brass
76.615054" X .070" ... Brass
76.621010" X .026" ... Steel
76.622024" X .040" ... Steel
76.623034" X .050" ... Steel
76.624044" X .060" ... Steel
76.625054" X .070" ... Steel
\$ 3.50 ea. ... 6 pkg. \$ 3.25 ea.

SQUARE BRASS TAPER PINS



SQUARE PINS IN Small, Medium, Large
50 Pieces in and Package. 1" long
76.506 .. Small 50 PC.020" - .060"
76.507 .. Medium ...50 PC.035" - .075"
76.508 .. Large50 PC.050" - .090"
\$ 3.50 Each 3 or more \$ 3.25 each



Brass Machine Nuts
10 Pieces per Package. Except
Number 75.400 This Package
Has only 4 pieces. Package are \$ 2.50 each.
6 or more packages \$ 2.25 each.

Part No.	Size	Width	Height
75.400	00-90	4/64"	2/64"
75.401	0-80	5/35"	3/64"
75.402	1-72	5/32"	3/64"
75.403	2-56	3/16"	1/16"
75.404	2-64	3/16"	1/16"
75.405	3-48	3/16"	1/16"
75.406	4-40	1/4"	3/32"
75.407	4-48	1/4"	3/32"
75.408	5-40	5/16"	7/64"
75.409	6-32	5/16"	7/64"
75.410	8-32	11/32"	1/8"



Zinc Plated Machine Nuts
25 Pieces per Package.
Package are \$ 2.50 each.
6 or more packages \$ 2.25 each.

Part No.	Size	Width	Height
75.411	0-80	5/32"	3/64"
75.412	1-72	5/32"	3/64"
75.413	2-56	3/16"	1/16"
75.414	2-64	3/16"	1/16"
75.415	3-48	3/16"	1/16"
75.416	4-40	1/4"	3/32"
75.417	4-48	1/4"	3/32"
75.418	5-40	5/16	7/64"
75.419	6-32	5/16"	7/64"
75.420	8-32	11/32"	1/8"



Brass Round Head Slotted Screws
12 Pieces per Package.
Packages are \$ 4.75 each.
6 or more packages \$ 4.50 each.

Part No.	Size	Length
75.721	2-56	3/16"
75.422	2-56	1/4"
75.423	2-56	3/8"
75.424	2-56	1/2"
75.425	2-56	5/8"



Brass Fillister Head Slotted Screws
12 Pieces per Package.
Packages are \$ 4.50 each.
6 or more packages \$ 4.25 each.

Part No.	Size	Length
75.726	2-56	1/4"
75.427	2-56	3/8"
75.428	2-56	1/2"
75.454	4-40	1/4"
75.455	4-40	3/8"
75.456	4-40	1/2"
75.457	4-40	3/4"



18-8 Stainless Steel Fillister Head Slotted Screws. 6 Pieces per Pkg.
Packages are \$ 2.75 each.
6 or more packages \$ 2.50 each.

Part No.	Size	Length
75.429	0-80	3/16"
75.430	0-80	1/4"
75.431	0-80	3/8"
75.432	0-80	1/2"
75.433	0-80	5/8"
75.434	1-72	3/16"
75.436	1-72	3/8"
75.438	1-72	3/4"
75.439	2-56	3/16"
75.441	2-56	3/8"
75.443	2-56	5/8"
75.444	3-48	3/16"
75.446	3-48	3/8"
75.448	3-48	5/8"
75.449	4-40	3/16"
75.451	4-40	3/8"
75.453	4-40	5/8"
75.458	4-48	1/4"
75.459	4-48	3/8"
75.460	4-48	1/2"
75.461	5-40	3/16"
75.462	5-40	5/16"
75.463	5-40	3/8"
75.464	5-40	1/2"
75.465	6-32	3/16"
75.466	6-32	3/8"
75.467	6-32	1/2"

Escutcheon Nails



50 pc brass nails to a package.
72.417 1/4" X # 18 \$ 1.50 pkg.
72.418 1/2" X # 18 \$ 1.50 pkg.
72.419 3/4" X # 18 \$ 1.50 pkg.
6 or more pkg. \$ 1.35 pkg.



1000 pices of Watch, Clock & Optical Screw Assortment. Has Brass & Steel Screws. Box is divided in to 11 Compartments. M0.5 to M1.5 Diameter.
75.482 \$ 19.75 ea.

Dial Screws

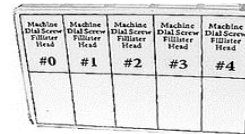

Machine Screws Assortment 20 Pieces.
4 of each size #0, #1, #2, #3 & #4
All screws are 3/8" long slotted Fillister Head Stainless Steel. In plastic box With labeled compartments.
75.480 \$ 7.00 ea.

Dial Screws

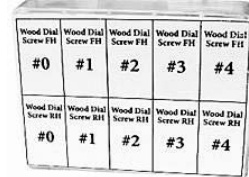

Wood Screws Assortment 40 Pieces.
4 of each size #0, #1, #2, #3 & #4
Screws are 1/4" & 3/8" long slotted Brass round and slotted In plastic box With labeled compartments.
75.481 \$ 7.00 ea.

Pivot Locator



New pivot locator with **smaller end** for Easier access to locate pivots.
8" long
24.569 \$ 0.00

Pivot Locator



Pivot locator for pushing or pulling pivot In to the pivot holes. 8" long with wood Handle for easy gripping.
24.567 \$ 5.25 ea.

Pivot Locator



Pivot Locator W/Knurled handle 8" long.
24.566 \$ 4.50 ea.

LEVELS



Level for leveling Clocks and etc.
The bubbled level measured 1-1/2" long.
24.700 \$ 2.00 ea.
12 to 23 \$ 1.75 ea.
24 and up \$ 1.50 ea.

KEYSTONE Oil

MAINSRING LUBRICANT

RECOMMENDED BY CRAFTSMEN FOR OVER 40 YEARS

Keystone Mainspring Lubricant will last longer and perform better than any other product for the demanding requirements of clock and instrument mainsprings. Features outstanding film strength will allow smooth power for years without binding, rusting, or galling. It stays where it is put! Keystone Lubricants contain NO graphite, moly, or sulphur to contaminate movements.

"The best mainspring lube is Keystone's #1 medium." says Jesse Coleman, one of America's most respected clockmakers, authors and lecturers. (Ref. "The Best of J.E. Coleman, Clockmaker" Page 263)

EXTREME PRESSURES...

Keystone Mainspring Lubricant has been tested to withstand pressures of over 300,000 lbs. per square inch by Gardner-Denver. A microscopic film of this extraordinary lubricant will separate the coils of metal so that full power is distributed smoothly and completely.

ANTI-RUST...

Keystone Mainspring Lubricant prohibits rust by actually displacing moisture caused by insufficient drying or high humidity conditions.

OXIDATION INHIBITOR...

Keystone Mainspring Lubricant retains its body and lubricity longer and prohibits oxidation longer than any other lubricant.

HIGH TACKINESS...

Keystone Mainspring Lubricant will cling to metal and won't wear off under the rigorous motion and tremendous pressure of winding and unwinding. IT STAYS PUT!

AVAILABLE IN TWO GRADES...

MEDIUM—most popular grade for American 8 day, 400 day, and most springs.

LIGHT—excellent for english, french, alarm, pocket watch, and all delicate mainsprings.

PROFESSIONALS ALSO USE AND RECOMMEND THESE FINE KEYSTONE LUBRICANTS...

KEYSTONE CLOCK PIVOT OIL...

The same fine qualities as the KEYSTONE MAINSPRING LUBRICANT. Recommended for use on all clock pivots.

KEYSTONE XL LUBE...

A light amber grease with outstanding lubricity. Excellent for use on all clocks, ratchets, cams, and lifting mechanisms.



MHSM103 ... MEDIUM \$ 8.00
 MHSL104... LIGHT \$ 8.00
 3 FOR \$ 23.00

MOEBIUS OILS and GREASES

Moebius Watch and Clock Oil has been acknowledged and acclaimed as the finest for generations. All Moebius products are developed, manufactured and tested in Switzerland. The large variety enables you to choose just the right oil or grease for your particular purpose. Natural Watch Oils, a mixture of neatsfoot and mineral oils, are satisfactory except that, after a period of time in contact with metals, they change chemically and form a gummy substance. Synthetic Oils have the same lubricating properties as natural oils, but will not change over a period of time, so they will not gum up, cause corrosion, become acidic, creep, or spread.

Moebius Watch Oil: 8000



General purpose for Chronometers & Watches all calibers
 Up to 18L Outstanding Lubricant with minimal spreading
 And low freezing

42.364 4 ml Bottle \$ 50.25 ea.



Moebius Quartz Watch Oil: 9000

42.365 2 ML BOTTLE \$ 40.25 ea.



Moebius Clock Oil #3A: 8030

For Clock, Alarm Clock and Meters not directly exposed to low winter temperatures

42.360 20 ml Bottle \$ 20.75 ea.



Moebius Grease: 8300

General purpose grease – well suited to the winding and setting parts of watches. Also for uncoiled mainsprings, as well as for clocks springs.

42.512 20 ml Bottle \$ 20.50 ea.

KEYSTONE PIVOT OIL & GREASE



CLOCK PIVOT OIL CPO.

A light oil of fine quality for pivots in all clocks.
 Packaged in 2 oz. Glass bottles.

MHCP105 2 OZ Bottle oil \$ 6.00 ea.

XL LUBRICANT



A light grease for sliding surfaces, lifting mechanism, ratchet wheels And ect.

MHXL107 1 OZ Grease \$ 3.75 ea.

**We accept these Credit Card
 Unless other arrangement are Made.**



PRICES SUBJECT TO CHANGE WITHOUT NOTICE

ETSYNTHA OIL & GREASE



ETSYNTHA 859 CLOCK OIL
 ESOL859-35 ... 3.5 ml \$ 14.00
 ESOL859-20 ... 20 ml \$ 56.00



ETSYNTHA TYPE 3-5 CLOCK AND INSTRUMENT OIL.
 ESOL5-30 30 ml \$ 27.00



ETSYNTHA SILBER "B"
 WATCH OIL
 ESOL-35 3.5 ml \$ 28.50



ETSYNTHA B52 GREASE
 ESOL52-7 7 GRAMS..... \$ 12.50

MILE HI PENETRATING OIL



(CAN BE USED TO LOOSEN OLD OIL AROUND PIVOT HOLES , TIGHT NUTS AND SCREWS)
 MHPO180..... 4 oz. \$ 6.50

NYE OILS



42.402 .. 1 oz clock oil \$ 11.25
 42.404 .. 2 oz clock oil \$ 14.50
 42.406 .. 4 oz clock oil \$ 25.75
 42.410 .. 1 pt. clock oil \$ 64.50
 42.442 .. 1 oz watch oil \$11.25

Plastic Syringe



Applicator can be used for lubricants, Adhesives, and other liquids. Round needle is not sharp and will not cut into materials. Hole Diameter is .023" 4-1/4" Long 2 cc.
 42.110 \$ 3.75 ea.

THE SYSTEM # 163 OIL



The System # 163 Clock oil is 100% Synthetic & extremely versatile lubricant. The System Clock Oil stays where you Put it. Does not spread, gum or oxidize. It is compatible with all metals & most plastics!
 42.104 1/4 oz. Bottle ... \$ 12.00 ea.
 42.105 1 oz. Bottle \$ 34.00 ea.



OILERS WITH OIL

ETSYNTHA OILER
 ESOLPK859 ... 4 ml 859 \$ 21.00
 ESOLPK500 ... 8 ml type 3-5 .. \$ 33.00

MH OILERS W / OIL & With Out Oil



15 CC W/ 3 1/4 SPOUT
 MHLS200 EACH \$ 2.25
 FOR 12 OR MORE EACH .. \$ 2.00
 MHLSE200 ... Empty \$ 2.00 ea.
 FOR 12 OR MORE EACH .. \$ 1.75
 MHRF201 . 8 oz REFILLS .. \$ 7.75
 8" EXTENSIONS FOR OILERS
 OLEX800..... \$.75 ea
 FOR 6 TO 11..... \$.55 ea
 FOR 12 AND UP..... \$.45 ea



POCKET OILER
 MHPK350 ... 3-1/4" Spout \$ 2.00 ea.
 FOR 12 OR MORE EACH .. \$ 1.75 ea.
 MHPK300 ... 1" Spout \$ 1.75 ea.
 FOR 12 OR MORE EACH .. \$ 1.50

OILERS



DIP OILERS SET OF 4 & 5 Pieces
 42.260 Set of 4..... \$ 12.50
 42.262 Set of 5..... \$ 17.25

Replacement Dip Oiler



42.250 Black Extra Fine Tip
 42.254 Blue Fine Tip
 42.256 Green Medium Tip
 42.258 Red Large Tip
 \$ 3.50 ea.

OILERS

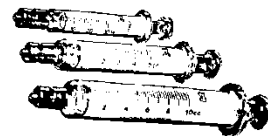

GLASS SYRINGES
 MGS002 2 CC SIZE \$ 18.95
 MGS005 5 CC SIZE \$ 21.35
 MGS010 ... 10 CC SIZE \$ 24.75

Novo Star Lubricants



This is a Swiss made lubricant that is a grease. You can use it on Mainsprings or levers in watches and clocks. 50 ml bottle.
 42.7311 \$ 17.50 ea.



Type R

This Nova Star oil can be used on alarm clock, pendulum clocks and watch escapements. 30 ml.
 42.7315 \$ 25.25 ea.



Type H

This Nova Star oil can be used for clocks, tower clocks and small mechanical movements. 30 ml.
 42.7316 \$ 35.50 ea.

SHELLAC



1/2 oz Bag . Used for holding pallet jewels and small parts.
 12.227 Shellac Flakes ... \$ 3.00

Main Spring Grease

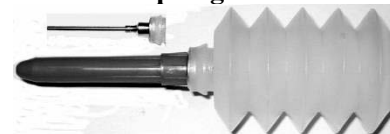

Mainspring grease in A bellow. Comes in 1 oz plastic squeeze bellow with 2" metal End. We have it with and with out grease.
 42.200 Empty \$ 2.00
 42.201 Full \$ 2.25
 Prices Subject To Change Without Notice



CLOCK MAINSPRING HOLE END

HOLE END	WIDTH		STRENGTH		LENGTH	DIAMETER	EA	PER 3
	INCHES	M/M	INCHES	M/M	INCHES	M/M		
CMH 23.1	3/32	2.30	0.007	0.18	18	14.00	\$ 2.50	\$ 7.20
CMH 40.2	5/32	4.00	0.008	0.20	24	17.00	\$ 5.70	\$ 16.60
CMH 40.6	5/32	4.00	0.011	0.28	26 1/2	22.00	\$ 3.25	\$ 9.45
CMH 48.1	3/16	4.80	0.009	0.23	24	17.00	\$ 2.90	\$ 8.00
CMH 56.1	7/32	5.60	0.008	0.20	26	20.00	\$ 5.40	\$ 15.70
CMH 56.3	7/32	5.60	0.010	0.24	24	18.00	\$ 3.50	\$ 10.00
CMH 64.2	1/4	6.40	0.011	0.28	15 3/4	MB	\$ 3.25	\$ 9.45
CMH 64.4	1/4	6.40	0.011	0.28	39	26.00	\$ 4.10	\$ 11.65
CMH 70.0	9/32	7.00	0.007	0.18	44	19.00	\$ 4.40	\$ 12.55
CMH 70.1	9/32	7.00	0.010	0.25	18	MB	\$ 5.40	\$ 15.70
CMH 70.2	9/32	7.00	0.010	0.25	39 1/2	25.00	\$ 6.00	\$ 17.10
CMH 80.1	5/16	8.00	0.008	0.20	27	18.00	\$ 3.80	\$ 11.10
CMH 80.5	5/16	8.00	0.010	0.25	28	19.00	\$ 5.15	\$ 15.00
CMH 80.7	5/16	8.00	0.010	0.25	32	23.00	\$ 3.80	\$ 11.10
CMH 80.8	5/16	8.00	0.010	0.25	39 1/2	25.00	\$ 4.60	\$ 13.40
CMH 80.12	5/16	8.00	0.011	0.28	45 1/4	28.00	\$ 4.65	\$ 13.25
CMH 80.13	5/16	8.00	0.015	0.38	40	34.00	\$ 4.65	\$ 13.25
CMH 80.15	5/16	8.00	0.016	0.41	54	38.00	\$ 5.15	\$ 15.00
CMH 87.2	11/32	8.70	0.013	0.33	66	38.00	\$ 6.60	\$ 18.80
CMH 90.3	23/64	9.00	0.011	0.28	45 1/4	28.00	\$ 7.55	\$ 22.00
CMH 90.4	23/64	9.00	0.013	0.33	18 1/2	MB	\$ 3.80	\$ 11.10
CMH 95.2	3/8	9.50	0.011	0.28	48	26.00	\$ 5.20	\$ 14.80
CMH 95.3	3/8	9.50	0.014	0.36	48	32.00	\$ 5.20	\$ 14.80
CMH 95.4	3/8	9.50	0.017	0.43	54	38.00	\$ 5.40	\$ 15.40
CMH 100.3	25/64	10.00	0.011	0.28	45 1/4	28.00	\$ 4.95	\$ 14.10
CMH 100.4	25/64	10.00	0.012	0.32	73	40.00	\$ 7.50	\$ 21.35
CMH 110.1	7/16	11.00	0.010	0.25	32 1/4	22.00	\$ 4.15	\$ 12.10
CMH 110.4	7/16	11.00	0.011	0.28	49	28.00	\$ 7.05	\$ 20.40
CMH 110.5	7/16	11.00	0.016	0.40	55 1/2	38.00	\$ 7.05	\$ 20.40
CMH 120.2	15/32	12.00	0.010	0.25	39 1/2	25.00	\$ 5.95	\$ 17.30
CMH 120.4	15/32	12.00	0.012	0.30	53	32.00	\$ 6.40	\$ 18.25
CMH 120.6	15/32	12.00	0.014	0.36	72	41.00	\$ 8.25	\$ 23.50
CMH 127.2	1/2	12.70	0.013	0.33	60	36.00	\$ 7.50	\$ 21.40
CMH 127.3	1/2	12.70	0.015	0.38	36	25.00	\$ 5.20	\$ 14.80
CMH 127.4	1/2	12.70	0.016	0.41	65	38.00	\$ 8.25	\$ 23.50
CMH 127.5	1/2	12.70	0.018	0.46	60	38.00	\$ 10.25	\$ 29.85
CMH 130.2	33/64	13.00	0.010	0.25	39 1/2	25.00	\$ 4.85	\$ 13.80
CMH 130.3	33/64	13.00	0.011	0.28	45 1/4	28.00	\$ 5.35	\$ 15.25
CMH 130.5	33/64	13.00	0.012	0.30	53	32.00	\$ 6.50	\$ 18.90
CMH 135.1	17/32	13.50	0.010	0.26	72	34.00	\$ 9.75	\$ 28.40
CMH 140.1	35/64	14.00	0.011	0.28	45 1/4	28.00	\$ 5.95	\$ 17.30
CMH 140.2	35/64	14.00	0.011	0.28	49	30.00	\$ 7.20	\$ 20.50
CMH 140.4	35/64	14.00	0.012	0.30	61	35.00	\$ 8.25	\$ 23.50
CMH 140.6	35/64	14.00	0.016	0.40	37 1/2	36.00	\$ 5.70	\$ 16.60
CMH 143.1	9/16	14.30	0.012	0.30	39	28.00	\$ 8.25	\$ 23.50
CMH 143.2	9/16	14.30	0.015	0.38	42	28.00	\$ 6.60	\$ 18.80
CMH 150.1	19/32	15.00	0.011	0.28	45 1/4	28.00	\$ 6.60	\$ 18.80
CMH 150.2	19/32	15.00	0.011	0.28	49	30.00	\$ 7.10	\$ 20.25
CMH 150.3	19/32	15.00	0.012	0.30	53	32.00	\$ 7.50	\$ 21.40
CMH 160.1	5/8	16.00	0.010	0.25	39 1/2	25.00	\$ 6.30	\$ 17.95
CMH 160.2	5/8	16.00	0.011	0.28	45 1/4	28.00	\$ 7.20	\$ 20.50
CMH 160.3	5/8	16.00	0.011	0.28	49	30.00	\$ 8.40	\$ 24.45
CMH 160.4	5/8	16.00	0.013	0.33	78	34.00	\$ 11.10	\$ 32.30
CMH 160.5	5/8	16.00	0.013	0.33	105	47.00	\$ 14.75	\$ 42.00
CMH 160.6	5/8	16.00	0.014	0.36	70	39.00	\$ 12.95	\$ 37.70
CMH 160.7	5/8	16.00	0.016	0.41	59	35.00	\$ 11.35	\$ 33.00

PRICES ARE SUBJECT TO CHANGE WITHOUT NOTICE.



CLOCK MAINSPRINGS HOLE END

HOLE END	WIDTH		STRENGTH		LENGTH		DIAMETER	EA.	PER - 3
	INCHES	M/M	INCHES	M/M	INCHES	M/M			
CMH 160.8	5/8	16.00	0.018	0.46	43 1/2	37.00	\$ 17.80	\$ 50.73	
CMH 160.9	5/8	16.00	0.018	0.46	72	40.00	\$ 16.20	\$ 47.15	
CMH 160.10	5/8	16.00	0.018	0.46	96	53.00	\$ 15.25	\$ 44.40	
CMH 160.11*	5/8	16.00	0.024	0.60	108	60.00	\$ 17.25	\$ 49.15	
CMH 170.1	43/64	17.00	0.010	0.25	72	34.00	\$ 10.75	\$ 30.65	
CMH 170.2	43/64	17.00	0.010	0.25	39 1/2	25.00	\$ 6.75	\$ 16.65	
CMH 170.3	43/64	17.00	0.011	0.28	45 1/4	28.00	\$ 11.10	\$ 32.30	
CMH 170.4	43/64	17.00	0.011	0.28	49	30.00	\$ 11.10	\$ 32.30	
CMH 170.5	43/64	17.00	0.018	0.46	54	40.00	\$ 14.00	\$ 40.90	
CMH 175.1	11/16	17.50	0.012	0.30	72	34.00	\$ 10.95	\$ 31.20	
CMH 175.2	11/16	17.50	0.014	0.36	54	34.00	\$ 10.25	\$ 29.85	
CMH 175.3	11/16	17.50	0.018	0.46	96	53.00	\$ 21.60	\$ 62.20	
CMH 180.2	45/64	18.00	0.011	0.28	49	30.00	\$ 9.00	\$ 25.65	
CMH 180.3	45/64	18.00	0.012	0.30	53	32.00	\$ 9.00	\$ 25.65	
CMH 180.4	45/64	18.00	0.012	0.30	61	35.00	\$ 10.25	\$ 30.85	
CMH 180.5	45/64	18.00	0.016	0.41	56	39.00	\$ 14.85	\$ 43.20	
CMH 180.6	45/64	18.00	0.016	0.41	61 1/2	42.00	\$ 14.85	\$ 43.20	
CMH 180.7	45/64	18.00	0.018	0.44	70	45.00	\$ 14.60	\$ 42.50	
CMH 180.8	45/64	18.00	0.019	0.48	47	35.00	\$ 10.25	\$ 29.85	
CMH 180.9	45/64	18.00	0.021	0.53	48	40.00	\$ 10.25	\$ 29.85	
CMH 190.1	3/4	19.00	0.009	0.23	72	33.00	\$11.75	\$ 33.50	
CMH 190.2	3/4	19.00	0.010	0.25	39 1/2	25.00	\$ 6.95	\$ 19.80	
CMH 190.3	3/4	19.00	0.011	0.28	45 1/4	28.00	\$ 7.60	\$ 22.15	
CMH 190.4	3/4	19.00	0.011	0.28	49	30.00	\$ 8.55	\$ 24.90	
CMH 190.5	3/4	19.00	0.011	0.28	50	30.00	\$ 10.25	\$ 29.85	
CMH 190.6	3/4	19.00	0.012	0.30	53	32.00	\$ 8.55	\$ 24.90	
CMH 190.7	3/4	19.00	0.012	0.30	61	35.00	\$ 10.00	\$ 28.50	
CMH 190.8	3/4	19.00	0.012	0.30	75	35.00	\$ 11.65	\$ 33.20	
CMH 190.9	3/4	19.00	0.012	0.30	90	35.00	\$ 14.80	\$ 42.20	
CMH 190.10	3/4	19.00	0.013	0.33	54	32.00	\$ 11.35	\$ 33.00	
CMH 190.11	3/4	19.00	0.014	0.36	90	35.00	\$ 14.00	\$ 40.32	
CMH 190.12	3/4	19.00	0.015	0.38	72	38.00	\$ 11.75	\$ 33.50	
CMH 190.14	3/4	19.00	0.016	0.41	53 1/2	37.00	\$ 12.15	\$ 35.35	
CMH 190.15	3/4	19.00	0.016	0.41	56	39.00	\$ 13.50	\$ 39.30	
CMH 190.16	3/4	19.00	0.016	0.41	60	38.00	\$ 15.15	\$ 44.10	
CMH 190.17	3/4	19.00	0.017	0.43	44	35.00	\$ 7.75	\$ 22.55	
CMH 190.18	3/4	19.00	0.017.5	0.44	70	45.00	\$ 11.35	\$ 33.00	
CMH 190.19	3/4	19.00	0.018	0.46	96	53.00	\$ 17.25	\$ 49.15	
CMH 190.20	3/4	19.00	0.019	0.48	68 1/2	45.00	\$ 14.80	\$ 42.20	
CMH 200.2	25/32	20.00	0.011	0.28	45 1/4	28.00	\$ 8.60	\$ 25.00	
CMH 200.3	25/32	20.00	0.011	0.28	49	30.00	\$ 10.45	\$ 30.40	
CMH 200.4	25/32	20.00	0.012	0.30	53	32.00	\$ 9.85	\$ 28.10	
CMH 200.5	25/32	20.00	0.012	0.30	61	35.00	\$ 10.40	\$ 30.30	
CMH 200.6	25/32	20.00	0.016	0.40	53	38.00	\$ 9.85	\$ 28.10	
CMH 200.7	25/32	20.00	0.017.5	0.44	70	45.00	\$ 14.60	\$ 42.50	
CMH 200.8	25/32	20.00	0.018	0.46	76 1/2	48.00	\$ 23.75	\$ 69.10	
CMH 210.1	53/64	21.00	0.011	0.28	45 1/4	28.00	\$ 8.00	\$ 22.80	
CMH 210.2	53/64	21.00	0.011	0.28	49	30.00	\$ 15.15	\$ 44.10	
CMH 210.3	53/64	21.00	0.012	0.30	53	32.00	\$ 9.95	\$ 28.35	
CMH 210.4	53/64	21.00	0.012	0.30	61	35.00	\$ 10.10	\$ 28.80	
CMH 210.5	53/64	21.00	0.013	0.32	67	38.00	\$ 11.75	\$ 33.50	
CMH 222.1	7/8	22.20	0.011	0.28	49	30.00	\$ 9.90	\$ 28.20	
CMH 222.2	7/8	22.20	0.012	0.30	53	32.00	\$ 11.35	\$ 33.00	
CMH 222.3	7/8	22.20	0.012	0.30	61	35.00	\$ 11.65	\$ 33.20	

PRICES ARE SUBJECT TO CHANGE WITHOUT NOTICE.

* This Spring Used in the S.T. # 10 Movement

CLOCK MAINSPRING HOLE END



HOLE END	WIDTH		STRENGTH		LENGTH	DIAMETER		EA	PER 3
	INCHES	M/M	INCHES	M/M		INCHES	M/M		
CMH 222.4	7/8	22.20	0.012.5	0.32	67	38.00	\$ 14.60	\$ 42.50	
CMH 222.5	7/8	22.20	0.013	0.33	72	40.00	\$ 14.65	\$ 41.75	
CMH 222.6	7/8	22.20	0.015.5	0.40	50	37.00	\$ 17.30	\$ 50.35	
CMH 222.7	7/8	22.20	0.017.5	0.44	70	45.00	\$ 17.30	\$ 50.35	
CMH 222.8	7/8	22.20	0.018	0.46	84	49.00	\$ 16.50	\$ 48.00	
CMH 222.9	7/8	22.20	0.018	0.46	96	53.00	\$ 20.00	\$ 58.20	
CMH 222.10	7/8	22.20	0.019.5	0.50	56	42.00	\$ 11.60	\$ 33.10	
CMH 240.1	61/64	24.00	0.017.5	0.44	70	45.00	\$ 14.35	\$ 40.90	
CMH 240.2	61/64	24.00	0.018	0.46	76 1/2	48.00	\$ 16.20	\$ 46.20	
CMH 240.3	61/64	24.00	0.018	0.46	80 1/2	50.00	\$ 19.45	\$ 56.60	
CMH 240.7	61/64	24.00	0.0155	0.40	60"		\$ 16.50	\$ 48.00 Urgos	
CMH 250.1	63/64	25.00	0.018	0.46	78 1/2	49.00	\$ 16.20	\$ 46.20	
CMH 254.1	1	25.40	0.018	0.46	96	53.00	\$ 32.40	\$ 94.30	

S.T. Sonora Chime Exact Replacement CMH 254.3

CMH 254.3 1 0.022" 136" \$ 24.50 ea.

Exact Replacement CMH 254.3

S.T. Sonora Chime
1" X 0.022" X 136"
\$ 24.50 ea.



Chime Side Mainspring For Urgos

61/64 X .0155 X 60"

For UW 6 Chime

CMH 240.7 \$ 16.50 ea.

3 Pieces \$ 48.00



HERMLE SPRING



PART NO.	PRING NUMBERS	WIDTH		STRENGTH		LENGTH		PRICE
		IN	MM	IN	MM	IN		
CMH 120.30	NO. 30	15/32	12	.0155	40	43-5/16		\$ 7.25 ea. 3 or
CMH 120.31	NO. 31	15/32	12	.0134	34	45-17/64		\$ 7.25 ea. More
CMH 120.32	NO. 32	15/32	12	.0165	42	43-5/16		\$ 7.25 ea. \$ 7.00 ea.
CMH 120.33	NO. 33	15/32	12	.0125	32	45-17/64		\$ 7.25 ea.
CMH 170.21/50	NO. 21/50	43/64	17	.0155	40	47-1/4		\$ 9.25 ea. 3 or
CMH 170.20/56	NO. 20/56	43/64	17	.0155	40	47-1/4		\$ 9.25 ea. more
CMH 170.40	NO. 40	43/64	17	.015	38	43-5/16		\$ 9.25 ea. \$ 9.00 ea
CMH 170.52	NO. 52	43/64	17	.0165	42	47-1/4		\$ 9.25 ea.
CMH 170.10	NO. 10	43/64	17	.0177	45	58-1/2		\$ 10.25 ea. 3 or more
CMH 170.11	NO. 11	43/64	17	.0165	42	59-1/16		\$ 10.25 ea. \$ 10.00 ea.
CMH 210.41	NO. 41	53/64	21	.0155	40	61		\$ 12.75 ea. 3 or
CMH 210.54	NO. 54	53/64	21	.0165	42	74-13/16		\$ 12.75 ea. more
CMH 210.55	NO. 55	53/64	21	.0177	45	70-7/8		\$ 12.75 ea. \$ 12.50 ea.

HERMLE BARREL COMPLETE

Barrel Complete		Barrel Only		Barrel Complete		Barrel Only	
Part #	Barrel # Price ea.	Part #	Price ea.	Part #	Barrel # Price ea.	Part #	Price ea.
77.010	10 \$ 37.75	77.010B	\$ 17.50	77.041	41 \$ 41.50	77.041B	\$ 19.25
77.011	11 \$ 37.75	77.011B	\$ 17.50				
77.040/42	40/42 \$ 37.75	77.040/42B	\$ 17.50				
77.050	50 \$ 37.75	77.050B	\$ 17.50				
77.052	52 \$ 37.75	77.052B	\$ 17.50	77.054	54 \$ 45.75	77.054B	\$ 19.25
77.056/53	56/53 \$ 37.75	77.056/53B	\$ 17.50	77.055	55 \$ 45.75	77.055B	\$ 19.25
77.031	31 \$ 35.50	77.031B	\$ 17.50				
77.032/30	32/30 \$ 35.50	77.032/30B	\$ 17.50				
77.033	33 \$ 35.50	77.033B	\$ 17.50				
77.021 (Replaces 20) .. # 21 ..	\$ 37.75	77.021B	\$ 17.50				

Barrel Caps are Available use part number

77. cap Number (Sample 77.040C)

77.010 to 040 \$ 3.00 each

77.050 to 055 \$ 3.00 each

Prices Subject To Change Without Notice.

400 DAY MAINSPRINGS

PART NO.	HOROLOVAR	SPRING NO.	WIDTH	STRENGTH	LENGTH	PRICE
77.1224	12 X 24	15/32"	.015"	23"	\$ 12.00 ea.	
77.140	12 X 25	15/32"	.013"	27"	\$ 12.00 ea.	
77.1232	12 X 32	15/32"	.012"	48"	\$ 12.00 ea.	
77.150	13 X 30	33/64"	.014"	38"	\$ 12.00 ea.	
77.151	13 X 32	33/64"	.022"	28"	\$ 12.00 ea.	
77.158	14 X 25	35/64"	.013"	27"	\$ 12.00 ea.	
77.1428	14 X 28	35/64"	.016"	28"	\$ 12.00 ea.	
77.159	14 X 30	35/64"	.014"	32"	\$ 12.00 ea.	
77.1532	15 X 32	19/32"	.020"	30"	\$ 13.50 ea.	
77.172	16 X 36	5/8"	.018"	41"	\$ 13.50 ea.	
77.183	18 X 38	45/64"	.018"	44"	\$ 13.50 ea.	
77.207	19 X 32	3/4"	.016"	38"	\$ 13.50 ea.	
77.212	19 X 36	3/4"	.017"	45"	\$ 14.50 ea.	
77.208	19 X 38	3/4"	.016"	53"	\$ 14.50 ea.	
*77.240	19 X 40	3/4"	.018"	52"	\$ 15.00 ea.	

Note: This spring marked with * is found to work better in the J. Kaiser Universe Plates No, 1310 & 1311 Also in Badische Uhrenfabrik Plates No. 1015, 1016A & 1717. 400 day clocks

77.221	20 X 38	25/32"	.016"	53"	\$15.00 ea.
77.229	21 X 50	53/64"	.015"	100"	\$18.50 ea.

ENGLISH FUSEE CLOCK SPRING "HOLE END"

NO:	WIDTH	Barrel DIA	EA	NO:	WIDTH	Barrel DIA	EA	NO:	WIDTH	Barrel DIA	EA
CSE 26	1 1/8	X 2	\$ 32.00	CSE 31	1 3/8	X 2 1/8	\$ 52.00	CSE 21	1 5/8	X 2-1/8	\$ 56.00
Strength .0175"	Length 82.6"			Strength .0175"	Length 88.6"			Strength .0175"	Length 88.6"		
CSE 5	1 1/4	X 2	\$ 38.00	CSE 13	1 1/2	X 2	\$ 50.00	CSE 22	1 5/8	X 2 1/2	\$ 68.00
Strength .0175"	Length 82.6"			Strength .0175"	Length 82.6"			Strength .0175"	Length 114"		
CSE 6	1 1/4	X 2 1/8	\$ 44.00	CSE 14	1 1/2	X 2 1/8	\$ 52.00	CSE 23	1 3/4	X 2	\$ 68.50
Strength .0175"	Length 88.6"			Strength .0175"	Length 88.6"			Strength .0175"	Length 82.6"		
CSE 29	1 1/4	X 2 1/4	\$ 50.00	CSE 15	1 1/2	X 2 1/4	\$ 58.50	CSE 24	1 3/4	X 2-1/4	\$ 68.50
Strength .0175"	Length 94.4"			Strength .0175"	Length 94.4"			Strength .0175"	Length 94.4"		
CSE 30	1 3/8	X 2	\$ 45.00	CSE 16	1 1/2	X 2 1/2	\$ 64.00				
Strength .0175"	Length 82.6"			Strength .0175"	Length 114"						

CLOCK MAINSPRING LOOP END

LOOP END	WIDTH		STRENGTH		LENGTH	END	EA.	PER 3
	INCHES	M/M	INCHES	M/M	INCHES			
CML 32.5	1/8	3.20	0.010	0.25	19	OPEN LOOP	\$ 5.95	\$ 17.30
CML 36.2	9/64	3.60	0.009	0.23	25	OPEN LOOP	\$ 3.80	\$ 11.10
CML 40.2	5/32	4.00	0.009	0.23	26	LOOP	\$ 3.80	\$ 11.10
CML 43.1	11/64	4.30	0.012	0.30	26	LOOP	\$ 6.00	\$ 17.45
CML 48.2	3/16	4.80	0.010	0.25	23	LOOP	\$ 3.50	\$ 10.20
CML 48.4	3/16	4.80	0.012	0.30	31	OPEN LOOP	\$ 3.50	\$ 10.20
CML 48.6	3/16	4.80	0.016	0.41	54	LOOP	\$ 4.85	\$ 13.85
CML 50.1	13/64	5.00	0.010.5	0.26	25 1/2	OPEN LOOP	\$ 3.80	\$ 11.10
CML 56.1	7/32	5.60	0.011	0.28	24	LOOP	\$ 3.80	\$ 11.10
CML 56.2	7/32	5.60	0.017	0.43	30	OPEN LOOP	\$ 3.25	\$ 9.45
CML 64.4	1/4	6.40	0.010	0.25	26	OPEN LOOP	\$ 3.85	\$ 11.20
CML 64.6	1/4	6.40	0.012	0.30	41	OPEN LOOP	\$ 4.00	\$ 11.40
CML 64.7	1/4	6.40	0.013	0.33	24	LOOP	\$ 4.25	\$ 12.35
CML 64.8	1/4	6.40	0.016	0.41	54	LOOP	\$ 5.55	\$ 15.80
CML 70.4	9/32	7.00	0.009	0.23	30	LOOP	\$ 4.25	\$ 12.35
CML 70.7	9/32	7.00	0.012	0.30	27	OPEN LOOP	\$ 3.80	\$ 10.95
CML 70.8	9/32	7.00	0.012	0.30	30	LOOP	\$ 6.25	\$ 18.20
CML 70.9	9/32	7.00	0.017	0.43	48	LOOP	\$ 7.55	\$ 22.00
CML 75.1	19/64	7.50	0.015	0.38	39	OPEN LOOP	\$ 8.65	\$ 24.90

Prices Subject To Change Without Notice.



CLOCK MAINSPRING LOOP END

LOOP END	WIDTH		STRENGTH		LENGTH		EA	PER 3
	INCHES	M/M	INCHES	M/M	INCHES	END		
CML 80.1	5/16	8.00	0.009	0.23	20	OPEN LOOP	\$ 8.65	\$ 25.20
CML 80.2	5/16	8.00	0.009	0.23	36	OPEN LOOP	\$ 4.25	\$ 12.35
CML 80.3	5/16	8.00	0.010	0.25	30	OPEN LOOP	\$ 4.10	\$ 11.95
CML 80.6	5/16	8.00	0.013	0.33	24	LOOP	\$ 4.25	\$ 12.35
CML 80.7	5/16	8.00	0.013	0.33	26	LOOP	\$ 10.25	\$ 30.75
CML 80.8	5/16	8.00	0.013	0.33	30	LOOP	\$ 6.50	\$ 18.90
CML 80.9	5/16	8.00	0.015	0.38	42	LOOP	\$ 7.30	\$ 21.25
CML 80.10	5/16	8.00	0.016	0.41	54	LOOP	\$ 6.50	\$ 18.90
CML 80.11	5/16	8.00	0.016	0.41	72	LOOP	\$ 13.90	\$ 39.60
CML 80.12	5/16	8.00	0.017	0.43	42	OPEN LOOP	\$ 4.45	\$ 12.70
CML 80.13	5/16	8.00	0.020	0.51	46	LOOP	\$ 8.10	\$ 23.60
CML 95.1	3/8	9.50	0.011	0.28	51	LOOP	\$ 9.20	\$ 26.75
CML 95.3	3/8	9.50	0.013	0.33	34	LOOP	\$ 4.60	\$ 13.40
CML 95.4	3/8	9.50	0.014	0.36	48	LOOP	\$ 9.45	\$ 27.50
CML 95.5	3/8	9.50	0.014	0.36	60	OPEN LOOP	\$ 9.45	\$ 27.50
CML 95.6	3/8	9.50	0.015	0.38	53	LOOP	\$ 7.55	\$ 22.00
CML 95.7	3/8	9.50	0.016	0.41	60	LOOP	\$ 8.10	\$ 23.60
CML 95.9	3/8	9.50	0.017	0.43	96	LOOP	\$ 14.25	\$ 40.60
CML 95.10	3/8	9.50	0.019	0.48	48	OPEN LOOP	\$ 6.50	\$ 18.90
CML 110.1	7/16	11.00	0.014	0.36	72	LOOP	\$ 8.10	\$ 23.60
CML 110.2	7/16	11.00	0.018	0.46	48	LOOP	\$ 5.95	\$ 17.30
CML 110.3	7/16	11.00	0.018	0.46	60	LOOP	\$ 11.35	\$ 33.00
CML 127.2	1/2	12.70	0.015	0.38	84	LOOP	\$ 13.80	\$ 40.15
CML 127.3	1/2	12.70	0.016	0.41	66	LOOP	\$ 11.90	\$ 34.65
CML 127.5	1/2	12.70	0.018	0.46	60	LOOP	\$ 9.20	\$ 26.80
CML 127.6	1/2	12.70	0.018	0.46	96	LOOP	\$ 18.40	\$ 53.55
CML 143.1	9/16	14.30	0.015	0.38	78	LOOP	\$ 13.25	\$ 38.55
CML 143.3	9/16	14.30	0.018	0.46	96	LOOP	\$ 18.35	\$ 53.40
CML 160.1	5/8	16.00	0.013	0.33	69	LOOP	\$ 10.95	\$ 31.20
CML 160.2	5/8	16.00	0.018	0.46	96	LOOP	\$ 23.75	\$ 69.10
CML 160.3	5/8	16.00	0.0175	0.45	96	LOOP	\$ 6.50	
CML 175.1	11/16	17.50	0.015	0.38	108	LOOP	\$ 20.20	\$ 58.80
CML 175.2	11/16	17.50	0.018	0.46	96	LOOP	\$ 17.25	\$ 49.15
** CML 175.3	11/16	17.50	0.0165	0.42	96	LOOP	\$ 6.50**	
CML 190.1	3/4	19.00	0.012	0.31	72	LOOP	\$ 16.75	\$ 48.75
CML 190.2	3/4	19.00	0.014	0.36	108	LOOP	\$ 21.60	\$ 62.85
CML 190.3	3/4	19.00	0.016	0.41	78	LOOP	\$ 13.50	\$ 39.30
CML 190.4	3/4	19.00	0.017	0.43	120	LOOP	\$ 21.60	\$ 62.85
CML 190.5	3/4	19.00	0.018	0.46	96	LOOP	\$ 22.70	\$ 66.05
CML 190.6	3/4	19.00	0.020	0.51	96	LOOP	\$ 19.50	\$ 57.00
CML 190.7	3/4	19.00	0.016	0.41	108	LOOP	\$ 20.50	\$ 59.25
New*CML 190.9	3/4	19.00	0.0165	0.41	96	LOOP	\$ 15.00	\$ 42.75*
New*CML 190.10	3/4	19.00	0.0177	0.41	96	LOOP	\$ 15.00	\$ 42.75*
CML 206.1	13/16	20.60	0.018	0.46	96	LOOP	\$ 23.80	\$ 69.25
CML 222.1	7/8	22.20	0.018	0.46	96	LOOP	\$ 26.50	\$ 77.15
CML 254.1	1	25.40	0.018	0.46	96	LOOP	\$ 29.20	\$ 85.00
CML 190.5J	3/4 X .0175	96	LOOPEND	(JAPANESE STEEL)		** Japanese Steel Wound In India		
CML 190.5JJ	3/4 X .0165	96	LOOPEND	(JAPANESE STEEL)		* German Made		

\$ 6.50 ea....5 TO 10 \$ 6.25 ea. ... 11 to 19 ... \$ 6.00 ea. 20 and up \$ 5.75 ea.



**Asian Made Loop End
Mainspring CML 190.5A S**
3/4" X 0.018" X 96
\$ 8.50 each 6 to 9 \$ 8.25 ea.
10 to 15 \$ 8.00 each.
16 and more \$ 7.75 ea.



**German Made Mainspring
Loop End Mainspring**
3/4" X .016 X 108"

Loop End mainspring for
Seth Thomas 89, some
Session and Ingraham movements
CML 190.7 \$ 21.60 ea.

**8 Day & 30 Hour
Loop End Mainspring**

For 8 Day Clocks



Loop end mainspring. Japanese Steel
Wound in India. **5/8" X .0175" X 96"**
CML 160.3 \$ 6.50 ea.
5 TO 10 \$ 6.25 ea. 11 to 19 \$ 6.00 ea.
20 or more \$ 5.75

Loop end mainspring. Japanese Steel
Wound in India. **11/16" X .0165" X 96"**
This Spring can be used and is little
cheaper to use in American Clocks.
CML 175.3 \$ 6.50 ea.
5 TO 10 \$ 6.25 ea. 11 to 19 \$ 6.00 ea.
20 or more \$ 5.75

Loop end mainspring. Japanese Steel
Wound in India. **3/4" X .0165" X 96"**
This Spring can be used and is little
cheaper to use in American Clocks.
CML 190.5JJ \$ 6.50 ea.
5 TO 10 \$ 6.25 ea. 11 to 19 \$ 6.00 ea.
20 or more \$ 5.75

Loop end mainspring. Japanese Steel
Wound in India. **3/4" X .0175" X 96"**
This Spring can be used and is little
cheaper to use in American Clocks.
CML 190.5J \$ 6.50 ea.
5 TO 10 \$ 6.25 ea. 11 to 19 \$ 6.00 ea.
20 or more \$ 5.75

31 Day Loop End Mainspring



Loop end mainspring. Japanese Steel
Wound in India. **3/4" X .0145" X 170"**
CML 190.8 \$ 10.00 ea.
5 TO 10 \$ 9.75 ea. 11 or more \$ 9.50 ea.

CLOCK LOOP END WINDER



For Loop End mainsprings. Wind up
On mainwheel and arbor from clock.
24.752 \$ 9.50 ea.

30 Hour Loop End Mainspring



Loop end Mainspring for many of the
30hour clocks
CML 95.11 ... **3/8" X .0145 X 48"**
CML 80.14 ... **5/16" X .0145 X 42"**
\$ 3.00 ea. ... 3 pieces \$ 8.00

**STANDARD FLAT
MAINSRING CLAMPS**



The clamps are formed from flat steel
1/8" X 5/16" and are 1-15/16 I.D.
They are a must for 8 Day American
Springs.
KFM200 \$ 6.50

**SET OF FLAT
MAINSRING CLAMPS**



Set of 8 Flat Main Spring clamps Two
Of each size. The two larger sizes made
from flat steel 1/8" X 5/16. The two smaller
sizes are made from 1/8" X 1/4" flat steel.
KFM400 \$ 32.50 set
3 or more set \$ 31.75 set

Mainspring Removing Tool



This tool can help remove the mainspring
From the winding arbor like on American
Time and strike clocks. By pushing the
Narrow end next to the winding arbor and
Mainspring where it is hooked to the arbor
And turning slightly helps to unhook the
Mainspring from the winding arbor.
Over all length 5" Steel Hex stock so it
Can be used in Let down Handle.
12.323 \$ 24.50 ea.

LET DOWN KEYS Handle



Let Down handle only (Plastic).
24.628 \$ 14.25



Large Let-Down Handle (Plastic)
24.629 \$ 16.25

**Winding Arbor Support For
Keystone Mainspring Winder**

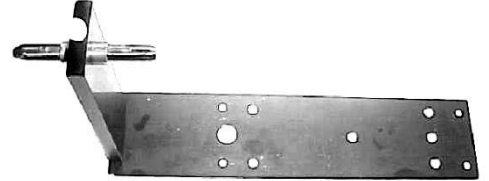

**20.326 Winding Arbor
Support \$ 75.00**

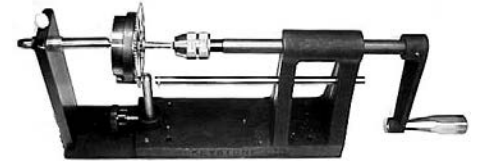

**Assembled View
CMW-2 \$ 375.00
CMW-2 and 20.326 Complete
\$ 450.00**

Taper Split Wedge

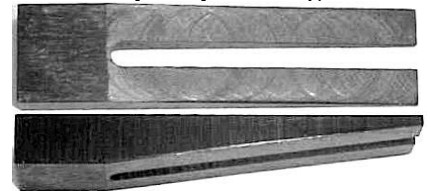

Taper split wedges to hold clock plates
Apart when trying to adjust wheels. It slides
between the plate and pillar sliding over
the thread of the pillar to separate the
plates. Two sizes of wedges.
Wedge 1/2" wide X 2" long X 1/4" thick.
This wedge will work on mantle clocks.
12.327 \$ 20.00 ea.

Wedge 1" wide X 2" long X 1/4" thick
This wedge will work on Floor Clocks..
12.328 \$ 25.00 ea.

Tapered Reamer



Ground and hardened steel
43.892 ... 3/16" to 1/2" ... \$ 8.00 ea.

KEYSTONE CLOCK MAINSPRING WINDER

Model CMW-2

MANUFACTURED BY CRAFTSMEN FOR CRAFTSMEN WITH PRIDE

CMW-2 \$ 375.00
 CMW-2 & Winding Arbor Support \$ 450.00

SIMPLE. A square chuck grips the arbor winding square — tighten by hand. Chuck range 2 to 5 mm (#0 to #13 key size). No wrenches or set screws to adjust. No damage to arbor.

A positive sliding lock. Handle is free to rotate in either direction — all the time. When locking is desired, just slide the lock . . . you know it's absolutely secure. No ratchet to reverse or wear out.

VERSATILE. Removable vise bar allows mounting in vise, on bench or on the wall. Left or right hand operation, horizontal or vertical, portable or permanent. (We even provide the hex wrench and mounting screws for your choice).

The CMW-2 winds both loop-end and hole-end springs of all sizes — even winds loop-end springs in the movement when click or ratchet is shot . . . so you can clamp the spring for disassembly.

COMPLETE. Nest of 11 spring retainers in sizes 1" to 2 3/4" for nearly any barrel size. Instructions, parts list and suggestions included.

UNCONDITIONAL GUARANTEE. Your complete satisfaction is assured or full purchase price refunded promptly without question. Workmanship and material guaranteed for one full year.

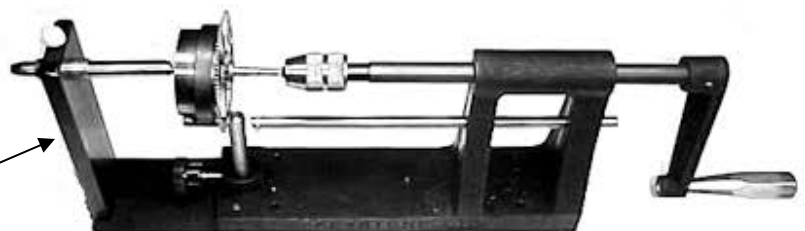
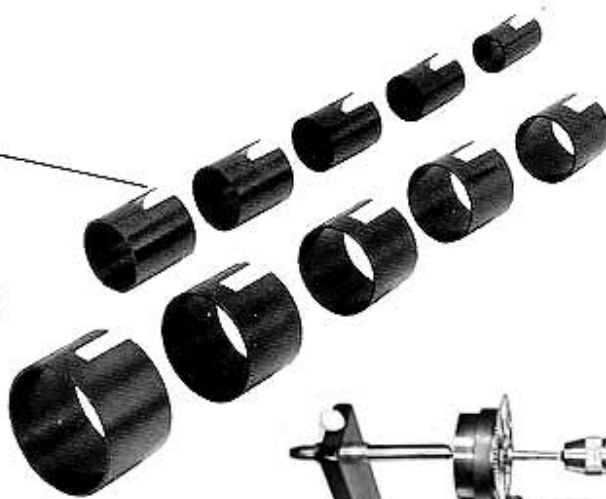
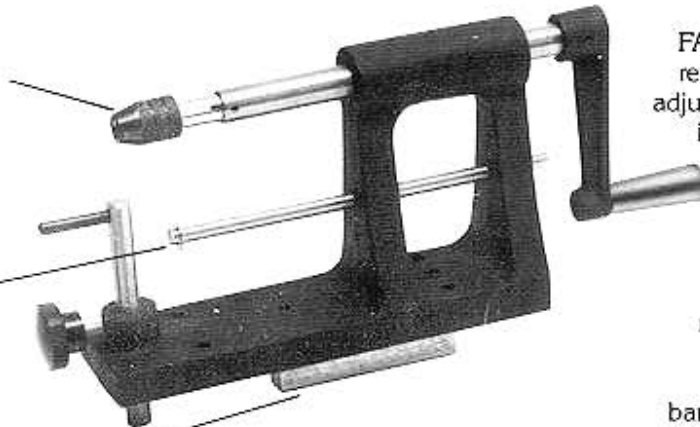

Winding Arbor Support

FAST. Winds, unwinds; inserts or removes; smoothly and easily. All adjustments, clamping, and sliding is done quickly by hand with no hooks, ratchet, wrenches or screwdrivers.

SAFE. A clamp to hold barrels while removing or inserting mainsprings. Resilient gripping surfaces grip firmly without distortion or damage to brass barrel. No need to use glove — no fear of injury to your hand. Adjusts easily to all barrel sizes and anchors firmly to tool.

Model CMW-2 includes:
 Tool complete with clamp, nest of 11 spring retainers, anchor pins for loop-end and hole-end springs, hex wrench, set of 5 universal arbors, 4 mounting screws, instructions and parts list.

Optional accessories:
 LAP-2A — Smaller loop-end anchor pin (for very small springs)
 Adapter for arbors larger than 5 mm (#13 key size)
 Flat mainspring clamps
 OBM — Beautiful Oak Bench Stand to hold the CMW-2 and all its accessories.

20.326 Winding Arbor Support \$ 75.00
 CMW-2 With Winding Arbor Support ... \$ 450.00

KEYSTONE CLOCKMAKERS DEPTHING TOOL

Model CDT-2

PRECISION TOOLS FOR THE DISCRIMINATING CLOCKMAKER

The clockmakers depthing tool holds a clock wheel and its mating pinion in the same position they will occupy in a completed clock. By turning the adjusting screw, depthing (or meshing) of the gears is determined exactly – and the distance between the pivot centers is then scribed onto the clock plates with the pointed runners of the tool. As pivot holes are then drilled in the clock plates at intersecting scribe marks, exact duplicating of depthing is assured for each wheel and pinion.

This unique tool offers the clockmaker, the repairman, and the collector a fast and easy way to adjust – observe – measure – prove – duplicate – troubleshoot – most every application of gearing in clockwork without having to partially assemble the movement. (Illustrated pamphlet is provided.)

The Keystone CDT-2 is machined from solid $\frac{3}{8}$ " nickel plated steel plate with V ways for runners and hinges precisely parallel milled. Solid black chromed brass set screws and adjusting knobs are turned and knurled. Runners and hinges are turned from quality tool steel.

Concealed torsion springs are contained **within** each hinge providing balanced tension through full adjustment range. Weight and balance is perfect for upright or reclined position on the bench.

An offset crank runner is provided for observing, adjusting, measuring, truing or depthing escape wheel/pallet combinations when the crutch follows the centerline of the escape wheel.

Model CDT-2 includes:

Tool complete with 3 scribing runners, 1 pivoting runner, 1 offset crank runner, beautiful storage/ carrying case with protective convolute foam padding and locking latches, illustrated suggestions pamphlet. (Note: Storage Case

Is now optional for \$ 35.00)

Dimensional Capacity

Wheel diameter (max.) $3\frac{1}{2}$ " (89 mm)
 Arbor lengths (max.) $3\frac{3}{4}$ " (95 mm)
 Distance between pivot centers $2\frac{3}{4}$ " (70 mm)
 Tool body - $3\frac{1}{4}$ " x $7\frac{3}{16}$ "
 Tool weight - $2\frac{1}{4}$ Lb.

Unconditional guarantee:

Your complete satisfaction is assured or full purchase price refunded promptly without question. Workmanship and material guaranteed one full year (obvious abuse excepted).

"The quality of a man's work can usually be known by the tools he uses, and the care he gives them."

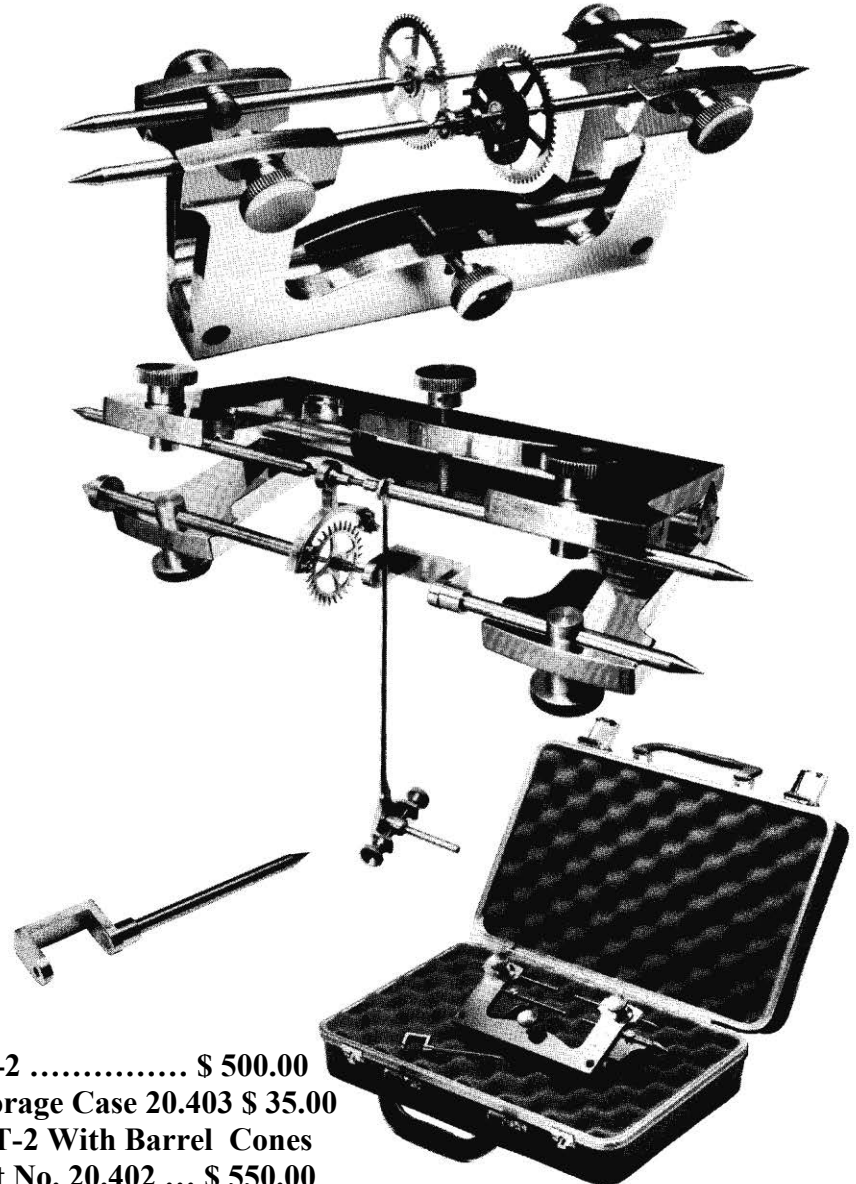

CDT-2 \$ 500.00

CDT-2 Storage Case 20.403 \$ 35.00

CDT-2 With Barrel Cones

Part No. 20.402 ... \$ 550.00

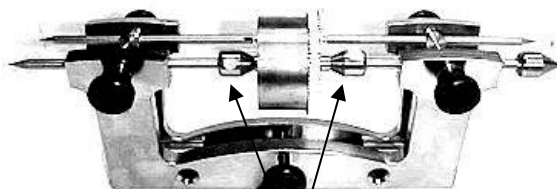

Hardened Pivot & pinion Wire



Hardened pivot wire that can be used for pivots or lantern pinions.

12 pc to a Package 6" long.

Part No	Wire Size	Drill No.
43.820	.020"	**
43.822	.022"	**
43.824	.024"	**
43.826	.026"	**
43.829	.029"	**
43.831	.031"	31
43.833	.033"	**
43.835	.035"	**
43.837	.037"	64
43.839	.039"	61
43.841	.041"	59
43.843	.043"	58
43.845	.045"	57
43.847	.047"	**
43.849	.049"	**
43.851	.051"	**
43.855	.055"	**
43.859	.059"	**
43.863	.063"	**

12 pc of a size per pkg. \$ 3.25 pkg.

3 or more Pkg. \$ 3.00 pkg.



Assortment of pivot – pinion wire 1 ea. of sizes 43.820 to 43.839 10 pc total.

43.800 \$ 3.50 pkg.

Assortment of pivot – pinion wire 1 ea. of sizes 43.841 to 43.863 9 pc total.

43.801 \$ 3.25 pkg.

Assortment of pivot – pinion wire

1pkg Each of 43.800 & 43.801 19 pc total.

43.802 \$ 6.25 pkg.

Steel Wire



Steel assorted wire sizes 20 to 70 by drill size. 6" length. 42 pc. Per Pkg.

43.700 \$ 13.25 pkg.

STEEL WIRES



STAFF AND PIVOT WIRE

Assorted sizes from 46 to 74 by drill size. 4" length 20 Pieces.

43.702 \$ 5.00 ea.

Blued Steel Wire



Blued Steel Wire Assortment
37 pc. .025 to .156 4-1/2" Long
43.703 \$ 4.50 pkg.

Brass Wire



Brass assorted wire sizes 20 to 70 by drill size. 6" length.

43.500 \$ 11.52 ea.

BRASS RIVET WIRE



6" length in assorted sizes from 14 to 21 by B&S gauge. Used to make pins, rivets hinges, etc. comes in 1 oz. Packages.

43.501 \$ 3.75 ea.

Nickel Silver Assortment

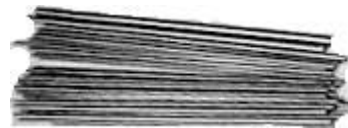

6" length in assorted sizes from 20 to 70 by drill gauge.

43.609 Nickel Silver \$ 9.75

SPRING WIRES



BRASS SPRING WIRE

Comes in 1 oz. spools. Sizes by B&S Gauge.

43.543 22 gauge \$ 7.00 ea.

43.544 24 gauge \$ 7.25 ea.

43.545 26 gauge \$ 8.25 ea.

Steel Binding Wire



Wire-Iron Binding .020 1/2-Lb,
43.638 \$ 7.75

Pivot & Pinion Wire Cutter



Handy tool for cutting pivot and pinion wire. Heavy duty for clean cuts. Will cut wire sizes from .65 mm to 1.65 mm. Adjustable stop for cutting several pieces the same length.

Has 4 holes so it can be mounted to bench.

43.875 \$ 51.75

ROUND STEEL SPRING WIRE



For making watch parts, loop springs and many items requiring spring steel. Tempered and ready to use. Comes in 36" coils, in B & S gauge sizes.

No.	B&S GAUGE	No.	B&S GAUGE
43.715	... 15	43.724	... 24
43.716	... 16	43.725	... 25
43.717	... 17	43.726	... 26
43.718	... 18	43.727	... 27
43.719	... 19	43.728	... 28
43.720	... 20	43.729	... 29
43.721	... 21	43.730	... 30
43.722	... 22	43.731	... 31
43.723	... 23		

Price ... \$ 5.25 ea. 3 or more \$ 5.00 ea.

Wobble Wedges

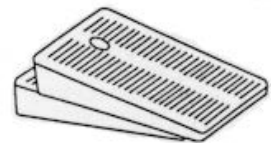

WW112 PKG OF 6 \$ 2.50

WW1100 ... PKG OF 100 ... \$ 28.00

Lathe Belting



Lathe belting 3/16 Dia., 3 ft. Long With 2 Couplers.

41.053 \$ 6.75

Brass Hammer



Brass hammer with 2 oz. Flat/Rounded Head the hammer face is 1/2" diameter 8" long with Hex Aluminum handle.
37.532 \$ 13.75 ea.

Brass Hammer



Brass head with wood handle. The Brass head is 5/8" diameter and Weighs 3 oz. Overall length is 9-1/8".
37.531 \$ 7.25 ea.

SOLID BRASS HEAD BRASS HEAD MALLET



Wooden Handle is of high quality and has just the right amount of spring. The head is 2" long and the face diameter is 1/2". Overall length is 8-1/4" and weigh 2 oz.
37.530 \$ 8.00

Swiss-Style Hammer

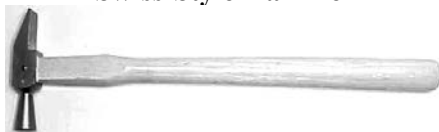

Small handy Swiss-Style hammer for Riveting, shaping & etc. 2-3/4" head 9-1/8" overall length. Weight is 2 oz.
37.244 \$ 7.50 ea.



Swiss-Style Hammer

Ideal for watchmakers or other light work One end is flat and the other is chisel shaped for spreading rivets. Forged head is mounted on hardwood handle.
2-1/4" Head.
37.240 \$ 8.00

Hammer Rawhide Mallet



For metalworking, where work cannot be marked or injured. Head is made of the finest quality rawhide, embedded in shellac. Head is O style 1" face 2 oz.
37.700 \$ 17.50



MALLET / DETACHABLE FACE
Faces can be changed to provide any combination desired and can be replaced when worn. Supplied with two different faces and wrench to tighten or remove collars.
37.536 ... 2" head, 2-1/2 oz. Head.
37.584 ... 2-5/8" head, 5 oz. Head.
37.536 Brass/Nylon \$ 14.50
37.584 Brass/Nylon \$ 21.75

REPLACEMENT HEAD

For Hammers
37.536 & 37.584



BRASS 2-1/2 oz. head
37.550 ... For 37.536... \$ 2.00 ea.
37.590 ... For 37.584... \$ 2.00 ea.

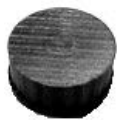

FIBER 2-1/2 oz. head
37.551 ... For 37.536 ... \$ 2.00 ea.
37.591 ... For 37.584... \$ 2.00 ea.



NYLON 2-1/2 oz. head
37.552 ... For 37.536 ... \$ 2.00 ea.
37.592 ... For 37.584... \$ 2.00 ea.

Brass Brush



German Made
Brass brush with four rows .003" wire. Brush is 3-1/4" long X 3/4" high. Overall length with wood handle 8-1/4".
16.310 \$ 8.25 ea.

Glasgow Cleaning Brush



German Made. Clock and Instrument cleaning brush. This brush is used for cleaning and dusting, Clocks, instrument and parts. Natural Bristles measure 4-1/2" long 3/8" deep. Overall length 10". Bristles Hard.
16.110 \$ 6.00 ea.
Bristles measure 4-1/2" long 3/8" deep. Overall length 10". Bristles 1/2 Hard.
16.111 \$ 6.00 ea.

Pliers Set Box Jointed



Set of 4 Box Joint Pliers in plastic pouch. 1 each of chain, flat, round and sidecutter. Pliers are 5" long.
46.495 \$ 28.75 set.

Clock Mainspring Forming Pliers



5-1/4" long
The jaws are so that these pliers can be used to form the end of mainsprings. Pliers are of a Box joint design to be more ridged.
46.729 \$ 15.00 ea.

Case Closing Pliers



Parallel Closing Jaws with circular, Rubber padded, hinged discs provide dependable case closing. Also works good for putting barrel caps back on mainspring barrels of clocks. Overall length 7-1/2"
46.805 \$ 14.25



Round Nosed .. 5 1/2" Long
46.310 \$ 20.75 ea.
46.312 ... Long Nose... \$ 21.50 ea.



Loop closing Pliers. Jaws are shaped & smoothly finished to close loops, chains links bows etc. 4-1/2" Long Box joint.
46.057 Cushion Grip \$ 14.50

Prices Subject To Change Without Notice.

PARALLEL ACTION PLIERS
 Quality-made, the unique parallel action design allows the jaws to open and close parallel to each other. This feature provides a vise-like grip on your work and gives the user greater leverage than conventional pliers

CHAIN NOSE PLIERS



The smooth jaws have a cross-slot for holding rod stock. Overall length 5". English Made
 46.520 \$ 42.00

FLAT NOSE PLIERS



The jaws are serrated or Smooth with a "V" slot. Overall length 5". English Made
 46.510 ...Serrated... \$ 32.25
 46.512 ... Smooth ... \$ 32.75
 Heavy Flat nose pliers. Overall length 5-1/2" Not English Made
 46.506 ...Serrated.... \$ 23.75



46.516 46.532

Not English Made

Combination Pliers, Flat nose with serrated jaws with "V" slot. Overall length 5-1/2"
 46.516 \$ 31.75
Parallel Action Cutters 5-1/2" Overall
 46.532 \$ 35.00

GERMAN BOX-JOINT EXTRA - DUTY



Box Joint insure lifetime alignment. German Made.
 Chain Nose ... 5" long
 46.300 \$ 20.75 ea.



Long Nosed Chain Pliers .. 5 1/2" long.
 Jaws 1 1/2" long
 46.302 \$ 21.50 ea.

GERMAN BOX-JOINT EXTRA - DUTY



Box Joint insure lifetime alignment.
Flat Nosed .. 5" Overall Length
 46.305 \$ 20.75 ea.



Long Nosed flat Pliers 5 1/2" Long
 The flat smooth jaws are extra long for special jobs. Jaws are 1-1/2" long.
 46.307 \$ 21.50 ea.



Sidecutters, Semi-Flush
 Hard Wire .. 5" Long
 43.315 \$ 26.75 ea.



End Cutters .. Semi-Flush 5" Long.
 43.320 \$ 33.75 ea.



Box Joint insure lifetime alignment. German Made.
 Bent Chain Nose 5" long
 46.350 \$ 23.00 ea.

HEAVY-DUTY RING-BENDING PLIERS



Box Joint insure lifetime alignment. Made in Pakistan ... Stainless Steel
 Economy Ring Bending pliers .. 6 1/2" Long
 43.330 \$ 17.25 ea.

Prices Subject To Change Without Notice.

HEAVY-DUTY RING-BENDING PLIERS Made In Germany .. Box-Joint



Box Joint insure lifetime alignment. The extra-heavy pliers are used for bending metals at right angles. Also can be used to adjust levers in clocks. 6 1/2" overall length
 46.731 \$ 45.25 ea.

Bending Pliers Box-jointed



This large 6 1/2" German made ring Bending pliers has a box-joint with cushion grip handles for maximum leverage. Jaws are concave/convex for shaping metal, with the convex jaw being slightly thinner than the concave jaw. Ground edges on the concave jaw minimize marring of precious metals. They can also be used to form mainspring end of clocks and etc..
 46.723 \$ 39.50 ea.

German Made 5 1/2" overall length



Concave/Convex Bending Pliers jaws
 Precision quality, box-joint pliers for all Bending applications. They can be used to form mainspring end of clocks and etc. German made overall length 5 1/2".
 46.725 \$ 26.75 ea.

Made in Pakistan Stainless Steel Box-Joint



5" bending pliers made of stainless steel box-jointed. Working surface are highly polished to prevent marring of metals. They can also be used to form mainspring ends of clocks and etc.
 46.730 \$ 14.25 ea.

**ECONOMY WATERPROOF
WATCH CASE OPENER**

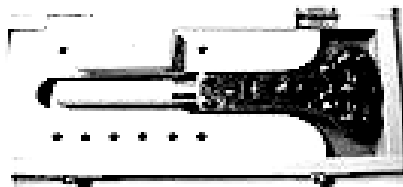

Includes sets of easy to insert jaw pins: round, flat, square and toothed. Provides a tight, non-slip grip that will not scratch or mar. Comes in a protective wood storage case.

59.0790 \$ 16.25

**VIGOR L-G MASTER
CASE OPENER
FOR WATERPROOF CASES**



Open any size or shape of case, knurled or polygon, with any number of slots, notches or holes. Gets a tight, non-slip grip that will not scratch or mar. Cover can be left in wrench ready for replacing. Complete with four sets of interchangeable jaw pins. Made in USA.

59.055 \$ 72.50

**RUBBER VACUUM CASE
OPENER**



For opening and closing screw backs and bezels. Has two sizes of cups for 0 to 18s watches.

59.048 \$ 5.00 ea.

WATCH CASE KNIVES



Blade Case Opener: polished and tempered Steel blade with knife edges. Mounted in hardwood handle.

Overall length 4-1/2".

59.0625 \$ 3.00 ea.

BLADE STYLE CASE OPENER



For opening friction fit cases. Well tempered steel blade set in hardwood non-roll handle.

Overall length 4-1/2"

59.047 \$ 7.50 ea.

HEAVY DUTY BENCH KNIFE



Economy model

Blade is firmly set in hardwood handle.

Blade length, 1-3/4"

39.0626 \$ 3.25 ea.

Quartz Case Opener



Quartz case opener with steel blade and knife edge, mounted in plastic.

59.0615 \$ 4.00 ea.

BERGEON LIFT LEVERS



Bergeon pair of levers for hands and wheels. Small size. 7.0 mm width X 4-1/4" long.

30011 \$ 68.50 ea.



Bergeon pair of levers for hands and wheels. Large size. 9.0 mm width X 4-1/4" long.

30012 \$ 68.50 ea.

Lifting Levers



Set of Two Pry-Bar With Knurled Handles

30.009 4" Long \$ 19.50 set

30.010 5-1/8" Long..... \$ 24.75 set

GLASS ALCOHOL LAMP



SIMPLICITY BURNER

With screw adjustment for wick. Faceted bowl diameter is 3 5/16 and holds 4oz. Of fuel. 3/16" dia. Wick.

14.287 \$ 7.75 ea.

Replacement Wick For 14.287

14.293 \$.75 ea

**HEAVY WEIGHT
COTTON GLOVES**



17.102 \$ 1.25 pr.

6 TO 11 pr \$ 1.10 pr.

1 Dz. (12) \$ 11.25 dz

Scotch-Brite Radial Disc

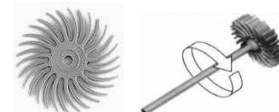

Scotch-Brite Radial Disc can be used To polish and clean parts. Disc are 3/4" Diameter. Comes in different Grit.

10.3503 400 Grit

10.3503 4 Pc \$ 4.75 pkg.

10.3504 Pumice

10.3504 4 Pc \$ 4.75 pkg.

10.3506 1 Micron

10.3506 4 Pc \$ 4.75 pkg.



Mounting Arbor Shaft 1/8"
43.162 Arbor \$ 0.75 ea.



Set of 3 Disc. and 1 Arbor

10.353 3 Pc kit ... \$ 4.25 pkg.

10.354 3 Pc kit ... \$ 4.25 pkg.

10.356 3 Pc kit ... \$ 4.25 pkg.

Prices Subject To Change Without Notice.

BUFF STICKS

Made in Germany

BUFF STICK FLAT EMERY

PART NO.	EA	For 6	For 12
11.340	4/0	1.75	\$ 8.75 \$ 16.75
11.341	3/0	1.75	\$ 8.75 \$ 16.75
11.342	2/0	1.75	\$ 8.75 \$ 16.75
11.343	1/0	1.75	\$ 8.75 \$ 16.75
11.344	1	1.75	\$ 8.75 \$ 16.75
11.345	2	1.75	\$ 8.75 \$ 16.75
11.346	3	1.75	\$ 8.75 \$ 16.75
11.347	4	1.75	\$ 8.75 \$ 16.75

EMERY PAPER



EMERY PAPER

Size of Sheet 9 X 13 3/4"

Made in the USA by 3M

PART NO.	GRIT
11.0776-4/0	4/0 800
11.0776-3/0	3/0 600
11.0776-2/0	2/0 500
11.0776-1/0	1/0 400
\$ 2.50 ea. 3 or more \$ 2.25 ea.	
12 and up \$ 2.00 ea.	

Fiberglass & Brass Scratch Brush



Removes rust and dirt from metal surfaces
Bristles can be screw-fed as they wear down.

16.332 ...Fiber Glass.....	\$ 6.50 ea
3 or more	\$ 6.25 ea.
16.328 ...Brass.....	\$ 7.75 ea.
3 or more	\$ 7.50 ea.

FIBERGLASS SCRATCH BRUSH REFILLS

Fiberglass and Brass Refills



16.329 16.333

Fiberglass Refills

16.333	Pkg. of 2	\$ 1.30 ea.
3 or more Pkg.		\$ 1.15 ea.

Brass Rifills

16.329	Pkg. of 2	\$ 1.75 ea.
3 or more Pkg.		\$ 1.60 ea.

Prices Subject To Change Without Notice:

MINIATURE WIRE BRUSHES



For cleaning, polishing and producing Special finishes. Precision made, excellent quality. Comes in Brass & Steel, mounted on

3/32" mandrel, with a 3/4" or 1" dia. Brush.	
16.0689 ... 3/4" Brass crimped ...	\$.80 ea.
3 or more	\$.75 ea.
16.0690 ... 1" Brass crimped ...	\$.90 ea.
3 or more	\$.85 ea.
16.0687 ... 3/4" Steel	\$.90 ea.
3 or more	\$.85ea.
16.0688 ... 1" Steel	\$ 1.00 ea.
3 or more	\$.95ea.

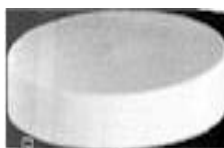

FELT BUFF

SOLID FELT WHEEL BUFF

Tightly compressed wool felt forms a Medium wheel for all-purpose polishing and buffing.

All have pin hole center. 4" dia 1/2" thick

17.435	\$ 9.25 ea.
--------	-------------

BUFF WHEEL



COMBED FINEST MUSLIN BUFF

With Leather Center. For use with rouge to produce a high finish.

3" dia. ... 35 ply ... 3 rows of stitching	
17.751	\$ 2.00 ea.
4" dia. ... 50 ply ... 3 rows of stitching	
17.757	\$ 2.75 ea.

Diamond Wheel & Mounting Arbor

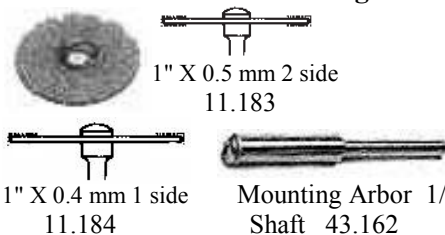

1" X 0.4 mm 1 side	Mounting Arbor 1/8" Shaft
11.184	43.162

Diamond Wheels for grinding, cutting & Etc.

11.183	2 Sides	\$ 19.50 ea.
11.184	1 Side	\$ 15.75 ea.
43.162	Arbor	\$ 0.75 ea.

-70-

POLISHING MATERIAL



ZAM BUFFING COMPOUND

Leaves a high luster without residue. Fast Clean-up.

47.502	1/4 lb. tube	\$ 4.50 ea.
--------	--------------	-------------

FABULUSTRE



Provides a high-luster finish on all types of metals. Removes light scratches and produces a fast, mirror-bright, final finish without discoloration. Greasless, dry but not dusty. Fast and easy clean up.

47.312	1/4 lb. Tube	\$ 4.50 ea.
47.313	1 lb. Tube	\$ 7.50 ea.



PRO-CRAFT VIGOR PEEL-BACK TUBES

GREEN ROUGE

Impart a high luster On hard metals such as Chrome, Stainless Steel or Platinum

47.321	6 oz.	\$ 5.00 ea.
--------	-------	-------------

RED ROUGE

For producing a final high color and luster on gold, silver and other soft metals.

47.323	7 oz.	\$ 6.00 ea.
--------	-------	-------------

TRIPOLI

A fine cutting abrasive for all Metals where rouge will be used for final Finish.

47.325	4 oz.	\$ 4.50 ea.
--------	-------	-------------

Yellow

For hard metals such as platinum, Chrome, and stainless steel. Leaves little Residue on work.

47.327	6 oz.	\$ 5.00 ea.
--------	-------	-------------

EMERY

Used on iron, steel and hard metals for coarse buffing and removing scratches, rust, corrosion, burs, etc. not for gold, silver or plated articles.

47.331	5oz.	\$ 4.25 ea.
--------	------	-------------

MINIATURE FELT WHEELS

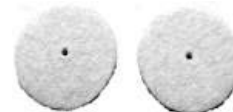

Solid felt for mandrel. 1" diameter By 1/4" thick. Made in soft grade.

17.380	2 to a pkg.	\$.50 ea.
3 or more pkg.		\$.45 ea.

Tapered Spindle Right



47.276	\$ 13.75
--------	----------

POLISHING COMPOUNDS

C-Clear



Makes old crystals new again. Removes scratches and blemishes. Wheel is charged with compound and crystal is then gently buffed.

47.310 5 oz \$ 6.25 ea.

Crystal Bright

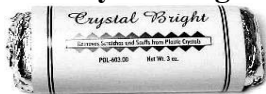

Makes old crystals new again. Removes scratches and blemishes. Wheel is charged with compound and crystal is then gently buffed.

47.311 3 oz \$ 5.00 ea.

POLYWATCH



Removes scratches from plastic watch Crystals. Apply a small amount of POLYWATCH to the crystal and polish With a cotton cloth. The scratches will disappear and the surface of the crystal will look as good as new.

47.002 Net wt. 0.175 oz. ... \$ 6.00 ea.

FLITZ METAL POLISH



Cleans, polishes and protects. Acid-free, Non-toxic, Non-abrasive paste rubs on Wipes off. Protects up to 6 months. Concentrated. For use on Gold, Silver, Platinum, Chrome, Copper and Marble.

47.457 50 gram \$ 15.00 ea.

POLISHING MATERIAL



SIMICHROME POLISH

Polishing paste. A soft, paste for polishing Brass, Silver, Chrome and other metals. One of the oldest and finest polish on the Market. Made in Germany.

47.557 50 Gr. Tube \$ 12.00 ea.

47.558 250 Gr. Can \$ 44.00 ea.

Prices Subject to Change Without Notice:

Curator Clock Case Restorer



Clock Case restorer, removes all dirt, grime wax, greases etc., restores the original beauty of the wood. Not a wax or Solvent. Won't harm French Varnish or polishes.

120 ml. Bottle. Made in England.

47.560 \$ 10.50 ea.

Curator Slate Blacking



Curator Slate Blacking can be used to Restore color to black marble & slate Clocks. Apply and buff to a high shine.

120 ml bottle. Made in England.

47.561 \$ 16.50 ea.

Bergeon Rodico

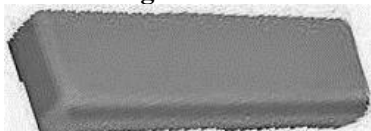

For cleaning of precision parts and small Gears. Removes surplus oils, loose dirt, Grime, grease, smudges and finger prints.

1 pieces per package.

6033 \$ 5.25 ea.

2 or more \$ 5.00 ea.

POLISHING CLOTHS



FABULSTER POLISHING CLOTH

A double sided cloth , one side impregnated with jeweler's rouge and the other side used for final polish, as well as to keep the user's hands clean.

Cloth size 9" X 11"

17.076 \$ 6.50 ea.



SELVYT CLOTH

Highest quality English-made polishing cloth. Soft, velvety, no-lint texture polishes surfaces without scratching. It will retain its softness after repeated washing.

Cloth size 14" X 14"

17.082 \$ 12.75 ea.

-71-

PITHWOOD BUTTON



Ideal for cleaning pivot end and small Parts and the tips of dip oilers.

Assorted pieces, pack of 20 pc.

23.334 ...from USA \$ 8.50 ea.

IMPORTED PEGWOOD



Selected orangewood for cleaning pivot holes and various other uses.

NO DIA. LENGTH PRICE

23.300 2.0 mm .. 5 3/4" .. \$ 6.00 ea.

23.303 4.0 mm .. 5 3/4" .. \$ 8.00 ea.

23.304 6.0 mm .. 7" \$ 16.75 ea.

Brass Wire Brush



All Brushes have A Wood Hub with 1/4" hole

4" Brass brush with 4 rows .004 crimped Bristles. Brush produces a softer,satin or Matte finish.

16.446 \$ 12.50 ea.

4" Brass brush with 2 rows .004 crimped Bristles. Brush produces a softer,satin or Matte finish.

16.441 \$ 9.50 ea.

4" Brass brush with 2 rows .003 Stright Bristles. Brush produces a softer,satin or Matte finish.

16.427 \$ 12.50 ea.

Steel Wire Brushes



All Brushes have A Wood Hub with 1/4" hole

3" Steel brush with 4 rows .003 crimped Bristles. Cleans,Debur surfaces.

16.461 \$ 11.25 ea.

6" Steel brush with 2 rows .003 Stright Bristles. Cleans,Debur surfaces.

16.458 \$ 14.75 ea.

**Lathe Pivot Polishing
Set of 10 Arbors**

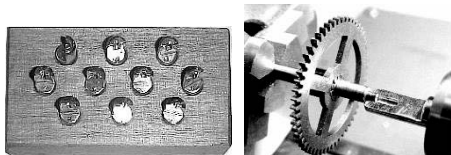

This set of Lathe Pivot Polishing Arbors Comes in a wood block.
87.605 \$ 45.00 set.

Manual Pivot Polishing Tool

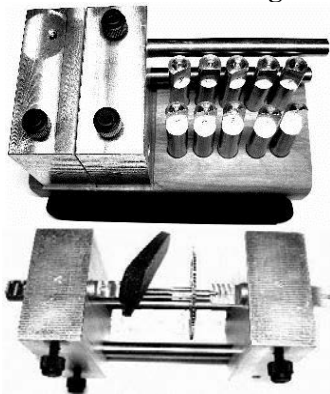

Polish pivots when you don't have all the lathes to polish pivots. By using the bar with a rubber edge you can power the wheel while you use a buff stick or other polishing tools.

There is 10 double ended arbors with the tool.

87.600 \$ 120.00



Pivot polishing stick to put your favorite Polishing paper on. Stick is 1/4" wide By 5-1/2" long. 12 pc to a package.

87.603 \$ 1.50 pkg.

**WALLER CARBIDE
GRAVER**



The new Waller Carbide Graver is a Special Watchmaker's grade of the World's hardest metals, Its extreme Hardness permits fast continuous cutting Of hardest stem, staff, pivots, etc.

36.820 \$ 18.00 ea.

**REPLACEMENT TIP FOR
GRAVER 36.820**



36.824 \$ 14.50 ea.

Prices Subject To Change Without Notice.

Grobet Carbon Steel Graver



Swiss Made
Square graver used for metal or wood.
36.194 2 mm Thick \$ 12.50
36.198 2.75 mm Thick \$ 12.50



Swiss Made
Lozene Graver used for metal or wood.
36.166 2.50 mm Thick \$ 12.50

Wood Graver Handle



1-3/8" X 1-3/4"

37.859 \$ 1.50 ea.

HARD ARKANSAS STONE



Mounted Hard Arkansas Stone. Is mounted in a cedar box. Natural close-density oilstone with qualities that make it unequalled for sharpening tool such as gravers, knives, etc.

Measurement is 4" X 2" X 1/2"
10.551 \$ 19.75 ea.

ARKANSAS SLIPS



Hard Arkansas slip Knife and Rounded Edge. Measures 2-1/4" X 7/8" X 3/16"
10.594 \$ 15.75 ea.



Hard Arkansas slip Beveled. Measures 3" X 3/8" X 1/8"
10.574 \$ 21.50 ea.

INDIA STONE



COMBINATION INDIA STONE; This stone has a fine Grit on one side and a medium grit on the other side. Measurement is 6" X 2" X 1"
10.451 \$ 18.25 ea.

HARD ARKANSAS SLIPS



Hard Arkansas slip Triangular Measures 2-1/2" X 1/8"
10.588 \$ 10.25 ea.



Hard Arkansas Square Slip Measures 2-1/2" X 1/8" X 1/8"
10.580 \$ 10.25 ea.

Crows Foot

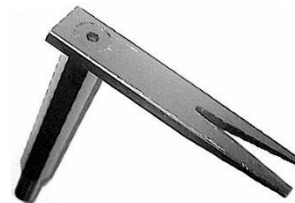

Crows foot can be used for Installing or Removing wheels. The anvil is 3-1/2" Long. The Extension is 4-1/4" high.
28.880 \$ 10.50 ea.

CROCKER PATTERN



GRAVER SHARPENER

Graver can be set to any angle by setting index. Holds graver edge in position while honing on oilstone.
36.880 \$ 52.50

We accept these Credit Card



SOLDERS



STAY-BRITE SOLDER

High strength silver bearing solder. Melts and flows at 430 deg.F. Kit contains 1/2 oz. (14g) of solder and 1/2 oz. (15ml) of flux.

54.452 \$ 19.75 ea.



TIX SOLDER

HARDEST SOFT SOLDER ON EARTH. melts at 275 deg. F. It has holding power of 4300 PSI. Adheres to all ordinary solderable materials and works with gun, Iron,torch or soldering machine. It comes in 3" sticks with 20 sticks per pkg.

54.808..... \$ 16.25 ea.



TIX FLUX

A non-corrosive flux, harmless to hands or clothing. Washes off with water even after drying. Works with any soft solder. 1/2 oz. Bottle.

54.460 \$ 4.75 ea.



TIX ANTI-FLUX

Prevent solder from flowing to unwanted areas. 1/2 oz. Bottle.

54.462 \$ 4.75 ea.

NATCHEZ WOOD POLISH AND WOOD FEEDER



ALL NATURAL Beeswax, lemon oil and Selected Minerals Oils as a wood feeder with no wax buildup. Polishes, protects and preserves.

NA800 8oz. Bottle \$ 9.00 ea.

LACQUERS



NIKOLAS 2105 CLEAR LACQUER

Produces the finest air drying lacquer for the protection of tarnishable solid or plated metals. Non-Toxic when Dry. Contains 12 fl. oz.

LQ2105 \$ 17.50 ea.

NIKOLAS GOLD COLOR SPRAY LACQUER



Spray lacquer produces a Simulated 24 kt. Gold Color when applied to polished or Satin finished brass. Contains ... 12 fl oz.

LQ2105G \$ 18.50 ea.

OXPHO-BLUE



4 oz. Bottle

Finest professional Cold Blue on the market original developed for the occasional bluer who is not equipped to completely polish the metal prior to bluing. With Oxpho-Blue all you need do in most cases, is dampen a piece of cotton flannel or Q-tip. The chemicals goes through the oil on the metal, removes thin rust and blue the steel underneath.No after rust.

59.841 \$ 11.75 ea.

Prices Subject to Change Without Notice.

Same as one dip

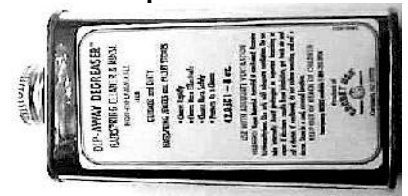

42.0508

"Dip Away " Degreaser & Cleaner

Cleans jewels pallet stones. Cleans rapidly, effectively, safely & protects as it cleans. Can be used to remove grease, oils, lubricants and many other contaminants from a wide variety of products. Cleaning action is thorough and gentle.

42.0508 1 Pint \$ 16.75 ea.

SUPER GLUE



Strong ethyl adhesive bonds any Combination of metal, plastic, rubber, ceramic and glass. Set and cures rapidly at room temperature. Bonds colorless and transparent with almost no shrinkage. 10/20 Series-setting time 10-20 seconds. 2 gram (.07 fl oz) tube 12.219 \$ 2.75 ea.

Also comes in 5 tube pkg. 5 -2 gr. Tubes 12.220 \$ 12.75 pkg.

CRYSTAL CEMENT



Provides excellent bond between plastic or glass watch crystals and bezel. Will not flake or crack plastic. Convenient tube with pin point applicator.

12.205 \$ 5.50 ea.

Caned Air



Dust Chaser used to remove dust in hard To reach places like on Watches and craft Items where dust need to be removed.

8 oz Can with nozzle 23.0971 \$ 13.25

Mantle Clock Back Doors



Black Painted Metal

- 25.575 3 3/4" \$ 4.25 ea.
- 25.550 4 1/2" \$ 4.50 ea.
- 25.525 5 1/4" \$ 5.00 ea.

MANTEL CLOCK FEET



Clock Feet, Cast reproduction feet used on Some American Clocks. Set of 4 pc. 15/16" tall 2 front and 2 rear feet per set. 40.101 ... Unfinished \$14.50 set.

Columns W/ Top & Bottom



Columns Sets .Comes in 1/2 Round Columns with Top and Bottom bases. Size 1/2 wide and 3/4 wide. Columns are black metal. Can be cut to length.

- 40.102 1/2" \$ 6.00 set.
- 40.103 3/4" \$ 6.00 set
- 2 or more Set \$ 5.75 set.
- 40.104 ... 1/2" Top & Bottom.. \$ 3.00ea.
- 40.105 ... 1/2" Column only... \$ 3.00ea.
- 40.106 ... 1/2" Top & Bottom.. \$ 3.00ea.
- 40.107 ... 3/4" Column only... \$ 3.00ea.
- 2 or more \$ 2.75 ea.

Lion Head



Lion Head with Ring. Unfinished. 2-5/8" high X 2-1/2" wide. 40.100 \$ 10.50 pr.

Key For Howard Miller Grandfather Clocks



Key is 1-11/16" Long
40.587 \$ 3.25 ea.

Door Locks

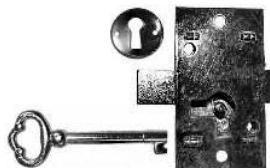

Door Lock with Key and Keyhole cover
Brass Plated lock 1" wide X 1-3/4" high
3/8" Deep. Keyhole cover is 1" diameter.
40.582 \$ 5.00

Lock With Key

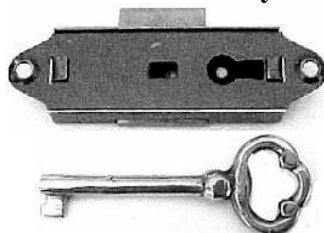

Narrow style lock surface mounted. Antique Bronze finish. 13/16" wide X 2-3/4" long. Uses 3/16" long tab key & 2 mounting screws
40.586 \$ 7.00 ea.

Key Only

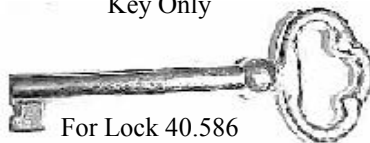

For Lock 40.586
Key is 2-3/8" Long
40.583 \$ 3.00 ea.

Lock With Key

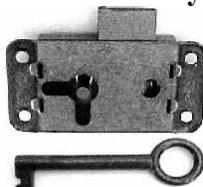

1" wide X 2" long Lock with Key for grandfather or Grandmother clock. Surface mounted. Uses 1/4" long tab key.
40.584 \$ 5.75

Key Only

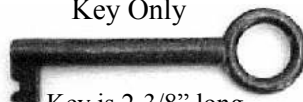

Key is 2-3/8" long
Key for lock 40.584
40.585 \$ 3.00 ea.

Door Hook & Eye



Brass Plated
40.120 ... 1/2" ... \$ 0.50 ea. 12pc \$ 4.75
40.121 ... 3/4" ... \$ 0.50 ea. 12pc \$ 4.75
40.122 ... 1" \$ 0.50 ea. 12pc \$ 4.75
40.123 ... 1-1/4" \$ 0.50 ea. 12pc \$ 4.75

Eye
40.128 ... 1/2" ... \$ 1.75 ea. 3 \$ 1.50 ea.
6 Pieces per Package.

Pendulum Tie Downs



Banjo Tie Down
Made of cast brass
2-1/8" long X 1/2" high.
76.481 \$ 5.50 ea.

Brass Door Hinges

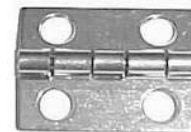

3/4" X 5/8"
73.075 pkg of 2 \$ 2.25 pkg.
6 or more pkg. of 2 pc. \$ 2.00 pkg.

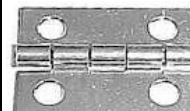

1" X 13/16"
73.076



1-1/4" X 13/16"
73.077

2 Hinges to a package \$ 3.00 pkg.
6 or more pkg. \$ 2.75 pkg.

Formed Door Latch



Brass Plated formed Kitchen clock Door latch. 1-1/4" long X 5/16" wide. 2 pieces to a package.
40.109 ... 2 pc. \$ 2.50 pkg.
Door Latch 1-5/8" Long X 7/16" Wide
40.110 ... 2 pc. \$ 2.50 pkg.

Turn Door Latches



1-1/2" long
40.111 "OG"



School House
1", 3/4"
9/16" & 3/8" long

40.111 ... 1-1/2" "OG"
40.112 ... 1" School house
40.113 ... 3/4" School house
40.115 ... 9/16" School house
40.116 ... 3/8" School house
\$ 3.00 ea. 3 or more \$ 2.75 ea.

Bezel Latch



No soldering required. Drill hole in bezel and install. 1" long X 5/8" wide.
40.114 \$ 3.00 ea.

Prices Subject To Change Without Notice.

Split Stake for Vise

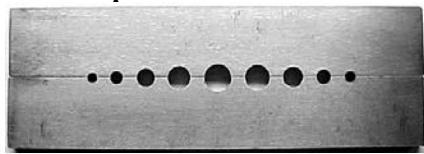

Top Side

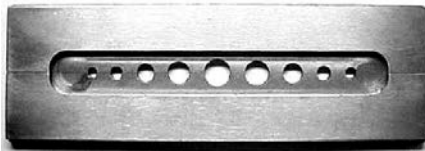

Under Side With Milled Slot
American Made

Split stake is made of two pieces of 1/4" Flat ground stock with a milled slot where the holes are to make 1/8" to easily hold lantern pinion and etc. Has 9 holes.

Hole sizes 1/8, 9/64, 11/64, 7/32, 1/4, 9/32 5/16, 11/32 and 3/8.

6" long X 2" wide.

12.321 \$ 75.00 ea.

Bench Style Split Stake



Top View



Side View
American Made

Bench split stake has 14 holes sizes size 3/32", 5/35", 7/32", 9/32", 11/32" 13/32", 15/32", 1/2", 7/16", 3/8", 5/16", 1/4", 3/16", 1/8",

Top is made of 2 pieces of 1/4 X 1 Flat ground stock. 10" long X 2" wide 2-5/8" high. 2" between top and bottom plate. This tool is also used for staking wheels on and off as well as working on lantern pinions.

12.325 \$ 175.00 ea.

Dapping Block

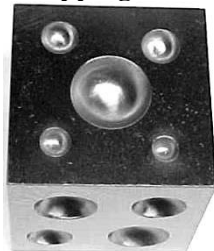

Dapping block handy for reforming Hand washers. The block is 2-1/2" sq. Hardened steel with 6 working surfaces With 17 various sized depressions up To 1-3/4" for forming all types of metals.

25.072 \$ 52.75 ea.

Prices Subject To Change Without Notice.

Dapping Punches

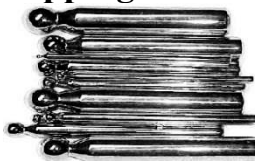

Set of 11 Dapping punches sizes 1/16" to 1" Handy for closing center shaft hole on clocks

Also to reform hand washers.

25.089 \$ 42.75 set.



Set of 12 Dapping punches in wood block. Sizes 1/2" to 1". Can form hand washers & Close center shaft hole in clocks.

25.712 \$ 60.50 set.

Drilling/Filing Tool Fixture



Made of Aluminum.

This tool is 4" hexagonal can be used for Third hand to holding parts that need to be Drilled, filed or cut. The aluminum fixture is 1/2" thick and 3 adjustment for the holding clamp..

12.329 \$ 23.00 ea.

Swiss Made Needle File



Set of 6 needle file Fine Cut. .5-1/2" long

33.907 \$ 31.50 set.

All Purpose File



General purpose file with rectangular shape One side **Single cut - one side double cut One edge is safe.**

32.498 8" long \$ 4.75 ea.

32.499 10" long \$ 5.75 ea.

Bull Foot File



This file can be used to adjust height of A bushing in the clock plate. Swiss Made.

Bull foot Bottoming Files Rectangle Shape 31.1311 \$ 28.75 each

Flat Needle File



31.502 ... 5-1/2 Swiss # 2 Cut ... \$ 10.75

Round Needle File



31.586 ... 5-1/2 Swiss #2 Cut ... \$ 11.00

Square Needle File



Square file for making square hole in Gathering pallets.

4" Square File Swiss Made # 2 Cut.

31.613 \$ 14.75 ea

Square Files



Square file for making round holes square. 3 different style.

4" Square File Swiss Made (Bastard Cut) 32.414 \$ 7.25 ea.

4" Square File Swiss Made (Second Cut) 32.421 \$ 7.75 ea.

4" Square File Swiss Made (Smooth Cut) 32.427 \$ 8.50 ea.



4" Screw Head File Swiss Made #1,2,&4

31.337 ... # 1 Thickness .032" ... \$ 41.75

31.338 ... # 2 Thickness .028" ... \$ 41.75

31.339 ... # 4 Thickness .022" ... \$ 41.75

Swiss Made Hand Files



Hand 6" Cut #2 Double cut Top & Bottom One edge single cut, One edge safty 31.146 \$ 22.75ea.



Equalling 6" Cut #4 Double cut Top & Bottom Both edge Single cut, 31.071 \$ 34.50ea.



Square 6" Cut #2 Double cut on all 4 sides 31.352 \$ 24.75ea.



Round 6" Cut #2 Double cut.

31.290 \$ 20.50ea.

**Grobet Flex Shaft Kit 1/8 HP
1/8 HP Ball Bearing Motor**



Requires no lubrication
1/8 HP Ball Bearing 110 volt Motor
20,000 rpm. Hand Piece With Chuck Key
Foot Pedal Control.
Flex Shaft Chuck Will Take Shanks
1/32" – 1/4" (0.79 – 6.35 mm)
34.600 \$ 149.75

Tap and Die Set

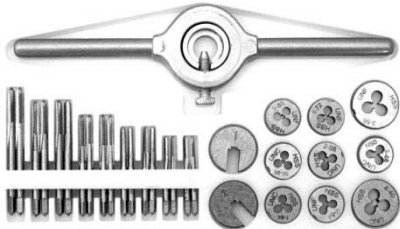

This set of 31 piece Tap & Die set has 9 Tap 2 of each Size and 9 Dies .
The die are 13/16" & 1/2" diameter.
Sizes # 00-90, # 0-80, # 1-64, # 1-72, # 2-64
2-56, # 3-56, # 3-48, and # 4-40
This set also has a tap handle and adjustable Die holder. 2 Tap Holding Die. All in and plastic box.
28.505 \$ 77.50 set

Hexagon Anvil

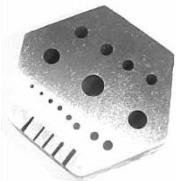

Used as a base for staking, riveting and Drilling of small parts. Case hardened and ground flat and smooth. Has 15 holes, graduated from 3/64" to 1/4", and 5 milled slots. Measures 1-5/8" across the flat side and 3/4" thick.
12.312 \$ 11.50

Brass Split Stake

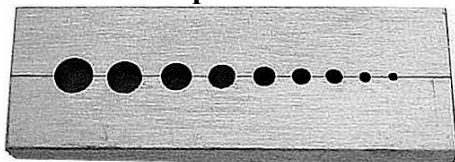

Split stake is 1" Wide X 3" long with 9 Holes go from 1.5 mm to 6 mm.
12.322 \$ 16.50

**Practical Clock Escapements
By Laurie Penman**

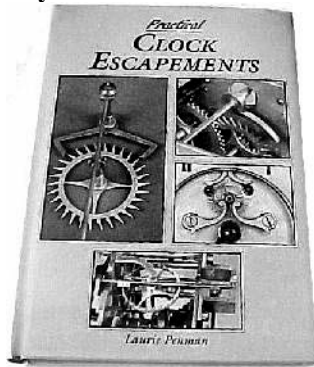

This book covers in depth five escapements Most commonly used in clocks.
This Book is Hardcover with 248 pages.
62.208 \$ 42.00 ea.

**Clock Repair Tips
By Bill Tipton**

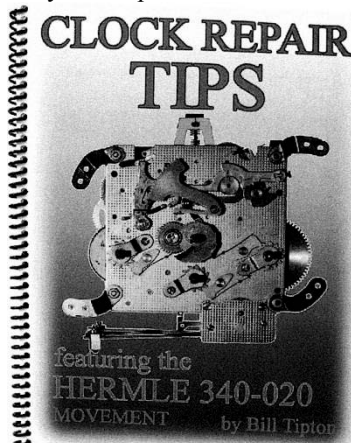

Coil bound, 133 pages how to trouble shooting. Problems in repairing a clock movement.
62.229 \$ 26.00

**Bench Notes and Schetches
By Bill Tipton**

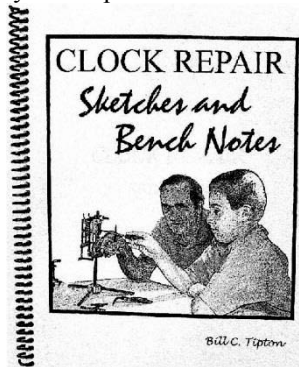

Coil bound Soft cover, 208 pages Handwritten sketches and bench notes Of 36 movement.
62.228 \$ 34.50

Prices Subject To Change Without Notice.

Cuckoo Clock Repair Made Simple



A good book on step by step repairing That favorite Cuckoo Clock. Lots of Pictures. 9-1/2" X 11" with 135 pages.
62.212 \$ 39.95

Black Forest Cuckoo



This book Black Forest Cuckoo Clock Tells the history of clock making in Germany As well as repairing of cuckoo Clock movement and case.
Soft Cover 266 pages
62.211 \$ 35.00

**400 Day Clock Repair Guide
By Charles Terwilliger**

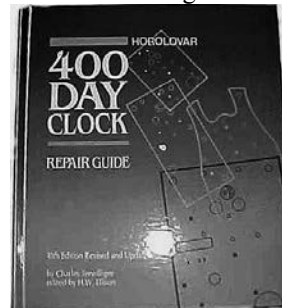

10 th Edition. Hard Cover, 237 Pages The very use full book for people that are interested on working on 400 day clocks. It has about the clock plates, Suspension Spring, Units & Mainspring .
62.230 \$ 28.50

How To Repair 20 American Clocks
By Steven Conover

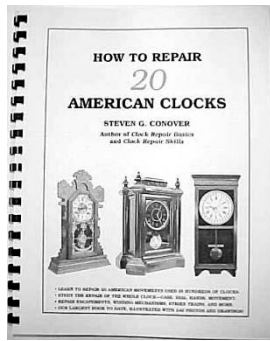

8-1/2" X 11" with a clear plastic cover. This Book covers assembly of 20 American Clocks Movements. Pinion and wheel count for time And strike trains. Mainsprings sizes for Movements. Beat per Hour. 140 pages with 246 photos and drawings.
62.200 \$ 29.50 ea.

Chime Clocks Repair
By Steven Conover

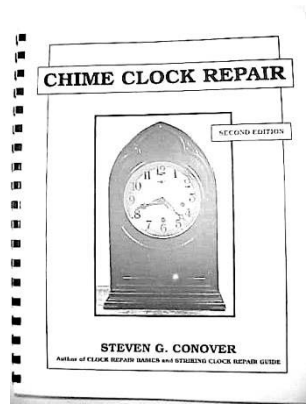

8-1/2" X 11" with a clear plastic cover. This book is a good guide for repairing American and European chiming movements. 126 pages.
62.203 \$ 27.50 ea.

How To Repair Herschede Clocks
By Steven Conover

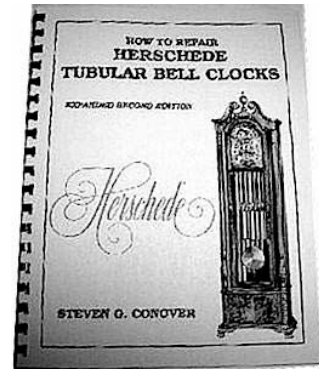

Book has illustration and drawing to help With adjusting and repair. 116 Pages.
62.210 \$ 28.50

Clock Repair Basics
By Steven Conover

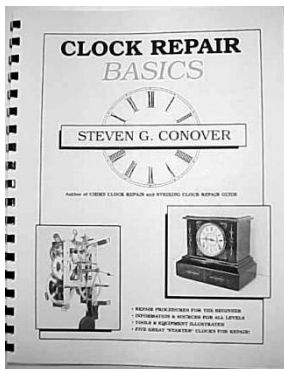

8-1/2" X 11" with a clear plastic cover. This Book tells how to let down mainspring, Cleaning, Disassembly, Repair & Reassemble. Has basic on bushing pendulums & Escapements and on lubrication. 92 pages 158 photo and drawings.
62.201 \$ 22.75 ea.

Striking Clock Repair
By Steven Conover

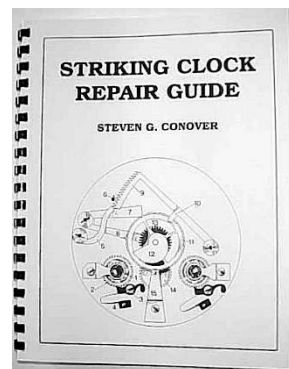

8-1/2" X 11" with a clear plastic cover. This book covers striking clocks. With Illustration and drawings. 90 pages.
62.204 \$ 22.75 ea.

Repair Book 1

By Steven Conover



From Clockmakers Newsletter articles published from 1987-2008. Repair tips & projects. Also section devoted to mainsprings & bushing methods. Soft cover. 190 pages.
62.241 \$ 38.00

Clock Repair Skills
By Steven Conover

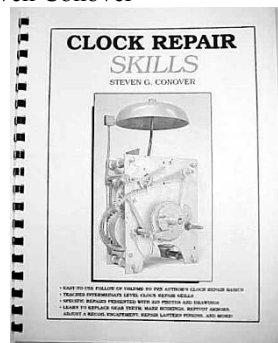

8-1/2" X 11" with a clear plastic cover. This book is more for the intermediate repairman. It deals with repairing lantern pinions, Repivoting, tooth replacement making Bushing, escapement repair. and more. 92 pages.
62.202 \$ 24.50 ea.

Repairing French Clocks

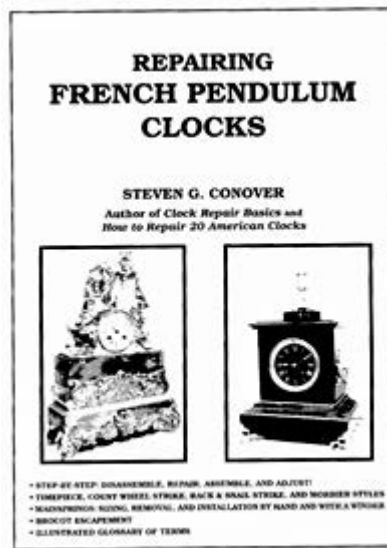

Repairing of French clocks by Conover
62.209 \$ 24.50 ea.

Tool Tips & Projects Book 2

By Steven Conover



From Clockmakers Newsletter articles Published from 1987-2008. How to use tools, hand tools you can make, workshop projects, & general repair tips. Soft cover. 181 pages.
62.242 \$ 38.00

Prices Subject To Change Without Notice.

Books By Robert Porter
The Art of Repivoting

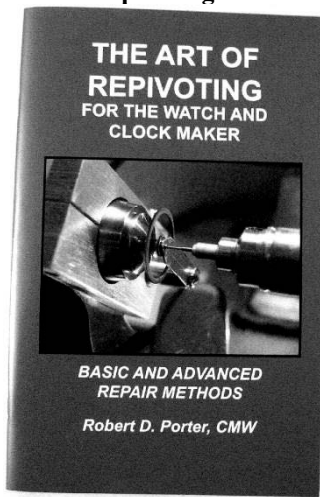

Soft cover, 60 pages how to do repivoting.
 62.222 \$ 13.75

Restoring Old Lathe
 By Robert Porter

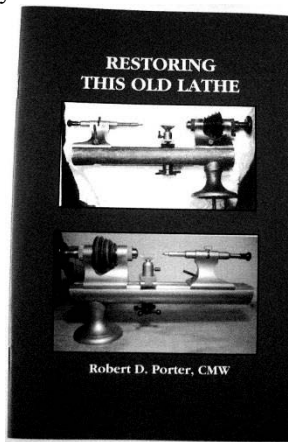

Soft cover, 24 pages how to restore old watchmaker lathe.
 62.223 \$ 8.00

The Clock & Watch Making to Gear Cutting By R.D. Porter



8.5" X 11" 192 Pages on the making of several types of gears and cutters for clocks and watches.
 62.221 \$ 34.25

Grinding Attachment
 By Robert Porter

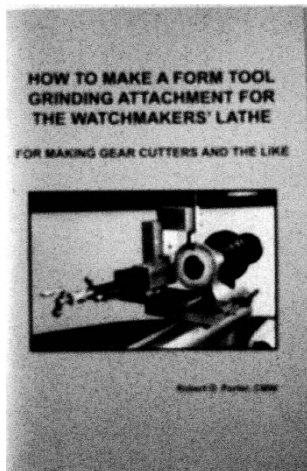

Soft cover, 20 pages how to make Attachment for lathe.
 62.224 \$ 8.00

Making Pivot Polishing
 By Robert Porter

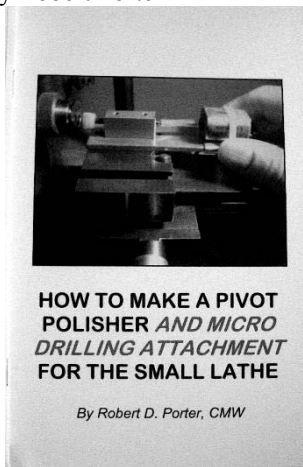

Soft cover, 24 pages how to make pivot Polisher for watchmaker lathe.
 62.227 \$ 8.00

Making Tiny Drills
 By Robert Porter

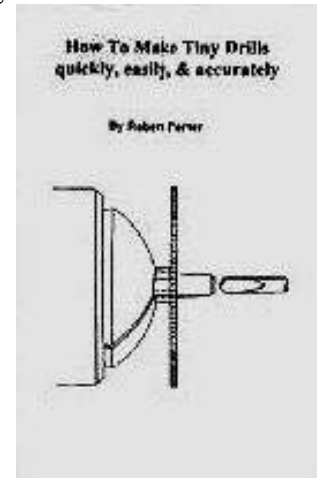

5.5" X 8.5" 16 Pages On the simple way of making tiny drill for Clock, Watches and Jeweler work.
 62.225 \$ 5.50

Micro Drill Press
 By Robert Porter

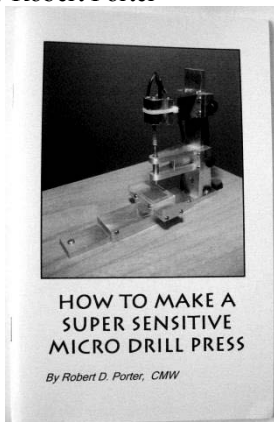

Soft cover, 40 pages how to make micro Drill press
 62.226 \$ 8.00

Books By Robert Porter
The Pin-Pallet Escapement

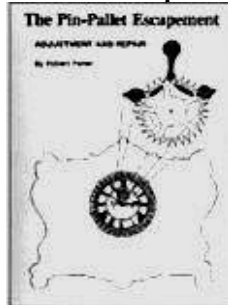

8.5" X 11" 44 Pages Showing how to help adjust the Brocot type pin-pallet escapement in American and European type clocks.
 62.220 \$ 12.75

Beat Setting Book

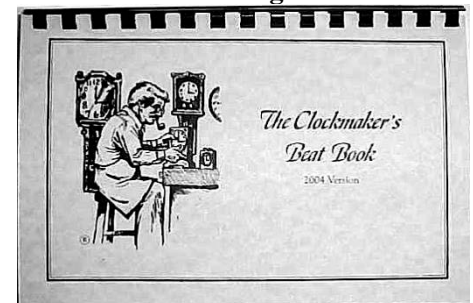

The Clockmakers Beat Book. 2015 By Jeff Hamilton. Contains Information on how to calculate clock trains For American and German movements. Bound in a soft cover.
 62.206 \$ 22.50 ea.

Prices Subject To Change Without Notice.

KEYSTONE TOOLS

KEYSTONE UNIVERSAL BUSHING TOOL

PART NO.	PRICE
UBM87K KWM Set Up	\$ 825.00
UBM87B Bergeon Set Up	\$ 825.00
SHIPPING AND HANDLING FOR BUSHING TOOLS	\$ 55.00

REPLACEMENT REAMERS:

PART NO.	REAMER NO.	REAMER SIZE	PRICE
24.415	# 1 American Made KWM Reamer	1.18 mm or .047"	\$ 16.00 ea.
24.416	# 2 American Made KWM Reamer	1.78 mm or .070"	\$ 16.00 ea.
24.417	# 3 American Made KWM Reamer	2.69 mm or .105"	\$ 16.00 ea.
24.418	# 4 American Made KWM Reamer	3.48 mm or .137"	\$ 16.00 ea.
24.420	# 5 American Made KWM Reamer	5.85 mm or .231"	\$ 16.00 ea.
24.421	# 6 American Made KWM Reamer	8.64 mm or .341"	\$ 17.50 ea.

BERGEON REPLACEMENT REAMERS: Swiss Made

PART NO.	REAMER SIZE	PRICE
6200/14	1.20 mm	\$ 22.50 ea.
6200/15	1.97 mm	\$ 22.50 ea.
6200/16	2.47 mm	\$ 22.50 ea.
6200/17	2.97 mm	\$ 22.50 ea.
6200/18	3.47 mm	\$ 22.50 ea.
6200/19	4.47 mm	\$ 22.50 ea.
6200/20	5.47 mm	\$ 22.50 ea.
6200/21	6.47 mm	\$ 22.50 ea.
6200/22	7.47 mm	\$ 22.50 ea.
6200/23	8.47 mm	\$ 22.50 ea.
6200/25	Chamfering Cutter 10 mm	\$ 25.75 ea.

REAMER ADAPTER:

20.400	For KWM Reamers	\$ 35.00
20.401	For Bergeon Reamers	\$ 35.00
20.404	Spring Loaded Stump	\$ 40.00

CLOCK MAINSPRING WINDER (CMW-2)

PART NO.	PRICE
CMW-2	\$ 375.00
CMW-2 With Winding Arbor Adaptor	\$ 450.00
SHIPPING AND HANDLING	\$ 45.00

ACCESSORIES:

PART NO.

20.300	Oak Bench Stand To Hold CMW-2 and its accessories	\$ 20.00
20.301	Small Loop-End Anchor Pin (for small springs)	\$ 14.00
20.302	Arbor Adaptor for arbor larger than 5 mm (# 13 Key)	\$ 20.00
20.303	Replacement Ring (set of 11)	\$ 65.00 set.
20.304 to 20.315	Individual Sizes , 1, 1-1/8, 1-1/4, 1-3/8, 1-1/2, 1-5/8, 1-3/4, 2, 2-1/4, 2-1/2, 2-3/4	\$ 7.50 ea.
20.316	Universal Arbors (Set of 5)	\$ 50.25 set.
20.317 to 20.322	Individual Arbors, 3/16, 1/4, 5/16, 3/8, 1/2	\$ 11.50 ea.
20.323	Replacement Barrel Clamp	\$ 85.00
20.324	Replacement Hole End Anchor Pin	\$ 12.00
20.325	Replacement Hole End Anchor Pin For Fusee Spring	\$ 15.00
20.326	Winding Arbor Support	\$ 75.00
20.327	7/8" Retaining Ring and Chuck Nut	\$ 25.00

KEYSTONE DEPTHING TOOL

PART NO.	PRICE	
CDT2	\$ 500.00	
20.402	Depthing Tool Barrel Cone Set of 2	\$ 50.00
20.403	Depthing Tool Storage Case	\$ 35.00



Hole End

CLOCK MAINSPRING

By Manufacturers



Loop End

Clock Springs for Ansonia Clocks

Size in Inches	End	Descriptions	Stock #
1/4 x .010 x 26	Loop	Alarm spring for Amazone, Flash, Pirate, Presto, Racket, Rally and Tourist. Time spring for Carriage.	CML 64.4
1/4 x .012 x 41	Loop	Time spring for Midget	CML 64.6
1/4 x .013 x 24	Loop	Time spring for Spark and Tot. Alarm spring for Tot.	CML 64.7
5/16 x .015 x 42	Loop	For E167 Time	CML 80.9
3/8 x .011 x 51	Loop	Strike spring for Carriage and Racket. Time spring for Tourist.	CML 95.1
3/8 x .013 x 34	Loop	Alarm spring for clatter, Tattler and Trump.	CML 95.3
3/8 x .014 x 60	Loop	Time spring for Amazone, Clatter, Presto, Racket, Rally, Repeater, Tattler, Trolley and Trump	CML 95.5
3/8 x .017 x 96	Loop	For 8-Day Capitol Clock.	CML 95.9
3/8 x .017 x 54	Hole	Time spring for Peep O Day	CMH 95.4
7/16 x .014 x 72	Loop	Alarm spring for Repeater and Trolley.	CML 110.1
9/16 x .018 x 96	Loop	For 8-Day Lever and Bungalo Clock.	CML 143.3
5/8 x .013 x 69	Loop	Time spring for Simplex.	CML 160.1
3/4 x .012 x 90	Hole	For Marquise Time and Strike.	CMH 190.9

Clock Springs for Chelsea Clock Company

Size in Inches	End	Descriptions	Stock #
17/32 x .010 x 72	Hole	Time Spring	CMH 135.1
43/64 x .010 x 72	Hole	Strike Spring	CMH 170.1

Clock Springs for China Plate

Size in Inches	End	Descriptions	Stock #
1/2 x .015 x 36	Hole		CMH 127.3
7/16 x .018 x 48	Loop		CML 110.2

Clock Springs for Gilbert

Size in Inches	End	Descriptions	Stock #
5/16 x .009 x 20	Loop	Alarm spring for All Time, Bi-Nite, Tornado Wake-up #'s 4570, 4581, 4582, 4584, 4586, and 4587.	CML 80.1
5/16 x .009 x 36	Loop	Alarm spring for All Time, Connecticut, Design, Radium #'s 4582, 45601 and 4602	CML 80.2
5/16 x .017 x 42	Loop	1-Day Alarm.	CML 80.9
3/8 x .016 x 60	Loop	Alarm spring for AllTime, Bi-Nite, Connecticut, Design, Radium, Tornado Wake-up #'s 4582 thru 4587	CML 95.7
1/2 x .013 x 60	Hole	Time spring for 4000 Series.	CMH 127.2
1/2 x .016 x 66	Loop	Alarm spring for "Nine" Clock.	CML 127.3
3/4 x .017 x 120	Loop	For 8-Day Pendulum, Time and Strike.	CML 190.4
3/4 x .018 x 96	Loop	For 8-Day Pendulum, Time and Strike.	CML 190.5

Prices Subject To Change Without Notice



Hole End



Loop End

CLOCK MAINSPRING

By Manufacturers

Clock Springs for Ingraham

Size in Inches	End	Descriptions	Stock #
1/4 x .010 x 26	Loop	Alarm spring for Comet, Dawn, Flyer, Indian, Rattler, Sentinel, Sentry and X-ray.	CML 64.4
9/32 x .017 x 48	Loop	Alarm spring for N.M. Admiral, Autocrat, Liberty and Victory.	CML 70.9
3/8 x .016 x 60	Loop	Time spring for N.M. Admiral, Autocrat, Liberty, Comet, Dawn, Flyer, Indian, Rattler, Sentinel, Sentry, Vin, Liberator, Liberty.	CML 95.7
1/2 x .016 x 66	Loop	Time Spring for Ace and Victory, Miller Plate, Miller Kitchen and Victorian, National Call.	CML 127.3
3/4 x .018 x 96	Loop	Time Strike spring for 8-Day Parlor and Mantle and Office Clock.	CML 190.5

Clock Springs for New Haven

Size in Inches	End	Descriptions	Stock #
5/32 .009 x 26	Loop	Alarm spring for N.M. Tattoo Junior, Tell Tale, Tick Tock and Tiny Tot.	CML 40.2
7/32 x .011 x 24	Loop	Alarm spring for Brownie, O.M. Tattoo Junior	CML 56.1
1/4 x .008 x 39	Loop	For Studebaker Auto Clock	CML 64.3
1/4 x .010 x 26	Loop	Alrm spring for Beacon.	CML 64.4
9/32 x .009 x 30	Loop	Time spring for Brownie, Tattoo Junior, Artlarm, O.S., Tell Tale, Tick Tock and Tidy Tot.	CML 70.4
3/8 x .013 x 34	Loop	Alarm spring for Commuter, Prompter, Slumber Stopper, Tattoo and Tom Tom.	CML 95.3
3/8 x .16 x 60	Loop	Time spring for Beacon, Commuter, Tell Tale Tick Tock, Prompter, Artlarm, St. Elmo, Recall and Tom Tom.	CML 95.7
1/2 x .015 x 84	Loop	Time Spring for Automatic Signal, Ti-Tan, Day. Alarm Spring for Automatic Signal, Ti-Tan, 8-Day.	CML 127.2
9/16 x .015 x 78	Loop	Time spring for Petite Time-Tambour	CML 143.1
5/8 x .014 x 70	Hole	For Ormond 9-Day Clock	CMH 160.6
3/4 x .009 x 72	Hole	Strike spring for Chime Clock.	CMH 190.1
3/4 x .012 x 72	Loop	Time and Strike spring for Class Reg.	CML 190.1
3/4 x .017 x 120	Loop	Time and Strike spring for 8-Day Combo #2.	CML 190.4
3/4 x .018 x 96	Loop	Time spring for 8-Day Combo.	CML 190.5
3/4 x .012 x 90	Hole	Strike spring for Harmonious and Duo Clock and #180	CMH 190.9
3/4 x .014 x 90	Hole	Time spring for Harmonious and Duo Clock and #180.	CMH 190.11
7/8 x .013 x 72	Hole	Time and Chime spring for Chime Clock.	CMH 222.5

Clock Springs for Parker Clock Company

Size in Inches	End	Descriptions	Stock #
1/4 x .011 s 39	Hole	Alarm spring	CMH 64.4
3/8 x .013 x 34	Loop	Alarm spring	CML 95.3
3/8 x .014 x 60	Loop	Alarm spring	CML 95.5

Clock Springs for Phinney Walker Clock Company

Size in Inches	End	Descriptions	Stock #
3/16 x .009 x 24	Hole		CMH 48.1
5/8 x .016 x 59	Hole		CMH 160.7
3/4 x .013 x 54	Hole		CMH 190.10

Prices Subject To Change Without Notice.



Hole End

CLOCK MAINSPRING

By Manufacturers



Loop End

Clock Springs for Sessions

Size in Inches	End	Descriptions	Stock #
1/4 x .013 x 24	Loop	For Kitchen Alarm, Jigger.	CML 64.7
5/16 x .008 x 27	Hole	For 30 Hour Clocks.	CMH 80.1
3/8 x .017 x 96	Loop	Time spring for Verdi Clock	CML 95.9
5/8 x .013 x 69	Loop	For all late model Alarm Clocks, Time and Alarm.	CML 160.1
5/8 x .014 x 70	Hole	For 8-Day Marine and Ormond Clocks.	CMH 160.6
5/8 x .016 x .59	Hole	Time and Alarm spring for all 8-Day Alarm Clocks.	CMH 160.7
11/16 x .018 x 96	Loop	Strike spring for Verdi Clock.	CML 175.2
3/4 x .018 x 96	Loop	For 8-Day Parlor, Kitchen and Banjo Clocks, Time, Strike and Chime spring for Chime Clocks.	CML 190.5
3/4 x .020 x 96	Loop	Session Two-Train Chiming, Chime Side	CML 190.6

Clock Springs for Seth Thomas

Size in Inches	End	Descriptions	Stock #
5/16 x .010 x 32	Hole	Movement # 102. Time Petite Clock.	CMH 80.7
5/16 x .016 x 54	Loop	Movement # 4. Strike spring.	CML 80.10
5/16 x .016 x 72	Loop	Movement # 673.	CML 80.11
3/8 x .011 x 48	Hole	Movement # 5100.	CMH 95.2
3/8 x .016 x 60	Loop	Movement #'s 1,3 and 109. Time Spring	CML 95.7
7/16 x .018 x 60	Loop	Movement # 6. Time spring.	CML 110.3
1/2 x .013 x 60	Hole	Movement # 116. Time spring.	CMH 127.2
1/2 x .016 x 66	Loop	Movement # 110. Time and Strike spring.	CML 127.3
1/2 x .016 x 65	Hole	Movement # 103 Time spring.	CMH 127.4
1/2 x .018 x 96	Loop	Movement # 3. Alarm spring.	CML 127.6
5/8 x .013 x 78	Hole	Movement # 7 & 103A. Time spring.	CMH 160.4
5/8 x .018 x 72	Hole	Movement # 2. Time spring. Ships Bell.	CMH 160.9
5/8 x .018 x 96	Hole	Movement # 11. Strike spring.	CMH 160.10
5/8 x .024 x 108	Hole	Movement # 10A. Time spring.	CMH 160.11
11/16 x .015 x 108	Loop	Movement #41 & 44. Time spring.	CML 175.1
11/16 x .012 x 72	Hole	Movement #125. Time spring.	CMH 175.1
11/16 x .014 x 54	Hole	Movement 115B. Time spring. Movement #'s 120 & 124. Time and Strike. Movement # 125. Strike spring.	CMH 175.2
3/4 x .017 x 120	Loop	Movement # 89 & 123. Time and Strike spring. Time and Strike. York #'s 1,2,5,6 & 7 Tambour.	CML 190.4
3/4 x .011 x 50	Hole	Movement # 115A.Strike spring.	CMH 190.5
3/4 x .016 x 108	Loop	Movement # 89 Time & Strike spring.	CML 190.7
3/4 x .012 x 90	Hole	Movement # 22 & 48. Time spring.	CMH 190.9
3/4 x .013 x 54	Hole	Movement # 51. Time and Strike spring. Movement # 105. Strike spring.	CMH 190.10
3/4 x .015 x 72	Hole	Movement # 124. Chime spring. Whitby Mahog. Cab.	CMH 190.12
3/4 x .016 x 60	Hole	Movement # 105 Time spring. Movements # 48 & 117. Strike spring.	CMH 190.16
7/8 x .018 x 84	Hole	Movement # 113. Time and Strike spring.	CMH 222.8
1 x .018 x 96	Hole	Movement # 113AB. Time and Strike spring and Chime spring.	CMH 254.1
1 x .022 x 136	Hole	Seth Thomas Sonora chime Movements No. 90, 104 and 119.	CMH 254.3

Prices Subject To Change Without Notice.



Hole End

CLOCK MAINSPRING

By Manufacturers



Loop End

Clock Springs for Waterbury

Size in Inches	End	Descriptions	Stock #
5/32 x .008 x 24	Hole	Alarm spring for Skip and Wanderer and 1-Day Lever Strike.	CMH 40.2
7/32 x .011 x 24	Loop	Alarm spring for Royal, Sunrise, Thrift, Turn-out, Twin, Vigilant and No-Sleep.	CML 56.1
5/16 x .013 x 24	Loop	Alarm spring for Vanitie.	CML 80.6
5/16 x .016 x 54	Hole	Spring for 1-Day Lever.	CMH 80.15
3/8 x .014 x 48	Hole	Time spring for Relay, Relay Junior, Royal Thrift	CMH 95.3
3/8 x .014 x 48	Loop	Time Spring for Must-Get-Up, Spasmodic, Sunrise, Turncut, Twin, Vanatie, Vigilant, 1-Day lever.	CML 95.4
3/8 x .015 x 53	Loop	Mickey Mouse	CML 95.6
1/2 x .018 x 60	Loop	Alarm spring for Must-Get-Up, Relay and Spasmodic	CML 127.5
3/4 x .012 x 72	Loop	Strike spring for Mantel Clock.	CML 190.1
3/4 x .014 x 108	Loop	30-Day Clock Time Side Strike spring for Chimes 34, 34D, 30 and 35. Also for 337 to 340 movements.	CML 190.2
3/4 x .016 x 78	Loop	Strike spring for Mantel Clock.	CML 190.3
3/4 x .017 x 120	Loop	Time spring for Chime 34, 34D, 35 and 30 Movement, also for 337 to 340 Movements.	CML 190.4
3/4 x .012 x 75	Hole	Strike spring for Mantel Clock, Time spring for 1-Day Cabinet	CMH 190.8
1 x .018 x 96	Hole	Time for 8-Day Lever Clock	CMH 254.1
Prices Subject To Change Without Notice.			

Hermle Barrel Numbers & Mainspring Sizes

Movement	Barrel #	Spring Size in Inches	Movement	Barrel #	Spring Size in Inches
130	Time # 32	15/32" X.0165 X 43-5/16	350 & 351	Time # 52	43/64" X.0165 X 47-1/4
	Strike # 31	15/32" X.0134 X 45-17/64		Strike # 50	43/64" X.0155 X 47-1/4
131	Time # 30	15/32" X.0155 X 43-5/16	351- 030A	Chime # 54	53/64" X.0165 X 74-13/16
	Strike # 33	15/32" X.0126 X 45-17/64		Time # 52	43/64" X.0165 X 47-1/4
132	Time # 31	15/32" X.0134 X 45-17/64	351- 050	Strike # 56	43/64" X.0155 X 47-1/4
	Strike # 31	15/32" X.0134 X 45-17/64		Chime # 55	53/64" X.0177 X 70-7/8
140	Time # 10	43/64" X.0177 X 58-21/32	1050 & 1051	Time # 52	43/64" X.0165 X 47-1/4
	Strike # 10	43/64" X.0177 X 58-21/32		Strike # 50	43/64" X.0155 X 47-1/4
141	Time # 11	43/64" X.0165 X 59-1/16	1050 - 030A	Chime # 55	53/64" X.0177 X 70-7/8
	Strike # 10	43/64" X.0177 X 58-21/32		Time # 52	43/64" X.0165 X 47-1/4
150 & 151	Time # 21	43/64" X.0155 X 47-1/4	1050 - 030A	Strike # 50	43/64" X.0155 X 47-1/4
	Strike # 21	43/64" X.0155 X 47-1/4		Chime # 55	53/64" X.0177 X 70-7/8
340 & 341	Time # 40	43/64" X.015 X 43-5/16	1050 - 030A	Time # 52	43/64" X.0165 X 47-1/4
	Strike # 40	43/64" X.015 X 43-5/16		Strike # 56	43/64" X.0155 X 47-1/4
	Chime # 41	53/64" X.0155 X 61		Chime # 55	53/64" X.0177 X 70-7/8

A

Adhesive Mounting Pad	25
Alcohol Lamp	69
Alarm-Kitchen	30
Anvil – Bench	75
Anvil – Hexagon	76
Ansonia Swinger unit & springs	5
Arbors	8
Arkansas Stone	72
Atmos Chain	13
Atmos Suspension Spring	12
Atmos Parts	12,13

B

Back Door - Clocks	74
Batteries	27
Batteries Converters	20,25
Bells – Brass	37
Bells Stand French	37
Bell Stand Tall Case	37
Bellow Top Material	32
Belting – Lathe	66
Bezels	14
Bezels Glass Tabs	35
Bezels Latch	74
Bezels With Glass	14
Books	76,77,78
Brass Brush	67,71
Brass Cable	9
Brass Hammers	67
Brass Washers	29
Bluing	73
Boxes Storage	47
Broaches	52
Brush – Cleaning	67
Brush – Fiber Glass Scratch	70
Brush –Brass Wheel	70
Brush – Steel Wheel	70
Buff Sticks Emery	70
Buff Wheel	70
Buffing Compound	70
Burnishers	53
Burnisher-pivot file/burnisher	53
Bushing Assortment	39,43,46
Bushings American System	43
Bushing Bergeon	39,40,41,42
Bushing Clock Hand	29
Bushing KWM	43,44,45
Bushing Tool-Hand & Drill	43,46,47
Bushing Tool Keystone	49
Bushing Tool Jig	47

C

Cable – Brass	9
Cable Ends – Hermle	9
Cable – Gut	8
Cable Guards	10
Cable – Ready Made	9
Calendar Conversion Units	30
Caliper	47
Canned Air	73
Case Openers-Watches	69
Chain	9
Chain Ladder	9
Chain Wheel	10

INDEX**C**

Chain Wheel Retainers	10
Chime Hammers	36
Chime Rods	36
Chime Rods Tuned	36
Clamps – Flat	63
Click Rivets	12
Click & Rivet Assortment	11
Click & Rivets	12
Click Spring	11,12
Click W/ Wire & Rivet	12
Clock Plate Spreader	55
Clock Staking Set	48
Columns Clock Case	74
Cord – Electric	25
Count Wheel Retainer	8
Counter Weights	38
Convex Glass	13,14
Crow Foot	72
Crystal Cement	73
Cuckoo Antlers	33
Cuckoo Bellow Tops	32
Cuckoo Bellow Top Material	32
Cuckoo Birds	32
Cuckoo Chain	9
Cuckoo Chain Ends	9
Cuckoo Chain Wheel	10
Cuckoo Deer Heads	33
Cuckoo Dials	32,33
Cuckoo Doors	33
Cuckoo Governor	32
Cuckoo Hands	32
Cuckoo Hand Nuts	29,33
Cuckoo Horn & mouth piece	32
Cuckoo Lift Wires	32
Cuckoo Material	32,33
Cuckoo Movements	32
Cuckoo Numbers	32
Cuckoo Pendulums	33
Cuckoo Pendulums Hook	33
Cuckoo Roof Clips	33
Cuckoo Tops	33
Cuckoo Weights	32

D

Dapping Block	75
Dapping Punches	75
Depthing Tool -Keystone	65
Decals	18
Dials Cutter	35
Dial Grommets	35
Dials – Metal	35
Dials – Paper	34
Dials – Pans	35
Diamond Wheel	70
Display Domes	12
Domes Glass	19
Domes – Clock	19
Door Hooks	74
Door Locks	74
Door Latches	74
Drilling & Filing Fixture	75
Drill -Carbide	50
Drill –Pivot	50

D

Drill –Set	50
Drill – Twist	50
Dummy Winding Arbors	27

E

E Clip	29
Escutcheon Nail	55
Escape Wheel Bridge	8
Escape Wheel	8
Escape Wheel Old English	8
Escape Wheel Hubs	8
Emery Paper	70
Eye Loops	37

F

Fabuluster Polish	71
Fast Slow Regulator	30
Feet for Mantel Clock	74
Felt Buff Wheel	70
File	75
File Set	75
Fiberglass Scratch Brush	70
File Pivot File & Burnisher	53
Flex Shaft Tool	76
Flux Tix	73
Flitz Polish	71
French Movement Strap	18
400 Day Base	38
400 Day Batteries	20
400 Day Beat Tool	20
400 Day Forks & Blocks	20
400 Day Parts	20
400 Day Main Springs	61
400 Day Spring Jig	20
400 Day Suspension Spring	20,21
400 Day Suspension Units	21
400 Day Wheels	20

G

Gathering Pallets	30
Glass – Atmos	13
Glass – Convex	13,14
Glass – Domes	19
Glass – Flat	13,14
Glass for Golden Hr. Clock	13
Glass O G	17
Glass – Revere	13
Glass Syringes for oils	57
Glass Tubeing	14
Glass Kitchen	15
Glass Regulator	16,17
Glue-Super Glue	73
Gong	36
Gong Base	36
Governors Clocks	30
Governors Cuckoo	32
Gloves Cotton	69
Gravers	72
Graver Sharpener Crocker	72
Grease	56,57
Grommets Dial	35

H

Hammers	67
Hammers Brass & Fiber	67
Hammer Rawhide	67

H

Hammers-Replacement Heads.....	36
Hammer Replacement Leather	36
Hammer Return Spring	36
Hands Adjusting Tool	29
Hand Bushing Brass	29
Hand Bushing Tool	48
Hands Mechanical Clocks	28
Hands Cuckoo	32
Hand Nuts	29
Hand Pullers	18
Hands – Quartz	25,26,27
Hand Washers	29
Hermle-Balance	5
Hermle Cable – Brass	9
Hermle-Pallet Fork.....	5
Hermle-Parts	10
Herschede Suspension Spring	5
Hinges	74
Hook & Rings	10
Hole Closing Punches	48

J

Joint Pins-Watch Cases	66
------------------------------	----

K

Keystone Bushing Tool	49
Keystone Lathe Support	75
Keystone Mainspring Winder	63,64
Keystone Oil	56
Keystone Tool Price List	79
Keininger Arbor Bushing	41
Keininger Cable	9
Keininger Cable Guards.....	10
Keininger Chain Wheel Retainer	10
Keininger Chain Wheel	10
Key – Door	74
Keys – Crank	2
Keys – 400 Day	2
Keys – Gauge	2
Key – Letdown Chucks	2
Key – Pendulet	2
Keys –Time Clock	3
Keys – Star	2
Keys – Watch	2
Key –Winding	1,2,3
Kitchen Clock Glass	15
Kundo Suspension Spring	6

L

Ladder Chain	9
Lathe Support	75
Landshire Electric Movement	25
Lacquer	73
Levels	55
Lever Adjusting Tool	2
Letdown Key Holder	2
Lift Levers	69
Lion Head	74
Loop End Winder	63
Lock- Door	74
Lubricants	56,57

M

Machine Nuts & Screws	55
Mainspring Clamp Flat	63
Mainspring – Clocks ...	58,59,60,61,62, 63

INDEX**M**

Mainsprings - 400 Day	61
Mainsprings – Fusee	61
Mainsprings – Hermle	60
Mainsprings Removing Tool	63
Mainspring Winder Keystone	63,64
Mainspring Winder Loop End	63
Motors – Electric	24,25
Movements	30
Movements-Alarm	30
Movements – Cuckoo	32
Motors – Golden Hour	25
Movement – Holder & Accessories.....	31
Movements Stands	31
Movement – Straps French Clock ..	18
Movements – Quartz	22 - 25

N

Nails – Escutcheon	55
Nut Machine	55
Nut Driver Set	51

O

Oils	56-57
Oilers Dip	57
Oilers Glass Syringes	57
One Dip	73
Optivisor	37
Oxpho-Blue -Bluing	73

P

Pallet Gathering	30
Pallet Jewels	8
Pegwood	71
Pendulums - Ansonia	3
Pendulums - Bobs	3-4
Pendulums Bob Wires	4
Pendulums - Cuckoo	33
Pendulums - French	3
Pendulum Hangers	8,31
Pendulum Hooks	3-4
Pendulum-Kitchen	4
Pendulum Leaders	8
Pendulum Rating Assemblies	4,5
Pendulum Rod	4
Pendulum Tie Downs	5, 74
Pendulum Rod Wood	4
Pendulum Ware Plate	5
Pendulum (Zaamdram)	3
Paper – Emery	70
Pinion-Gilbert	30
Pin Punches	51
Pin Vices	50- 51
Pithwood Buttons	71
Pivot File & Burnisher	53
Pivot Locator	55
Pivot Polishing Tool	72
Pivot Wire Cutter	66
Pivot Wire	66
Plate Spreader	31
Pliers	67-68
Pliers Set.....	67
Pocket Watch Displays	12
Polishing Cloths	71
Polishing – Compounds	70-71
Polishing – Crystal Kleer	71

P

Polishing For Cases	71
Polishing Disc from 3M	69
Polishing – Sticks	72
Polish Natchez	73
Poly-Watch Scratch Remover	71
Pry Lift Levers & Bergeon	69
Punch (Snap Punch)	51
Pulleys	10

Q

Quartz –Case Opener	69
Quartz – Chiming	22, 23
Quartz Dummey Arbors	27
Quartz –Extra Large Nuts	27
Quartz Fit – Up	24
Quartz Hands	26,27
Quartz Movements	22,23,24
Quartz Nut Hand Driver	22
Quartz Numbers	27

R

Ratchet Wheels	20
Reamer	63
Reamers – Bergeon	39,41,37,41,48
Reamers – KWM	43,40,41,48
Return Hammer Spring	36
Rodico - Bergeon	71
Rubber Watch Case Opener	69

S

Saw Blades	53
Saw Frame	53
Scratch Brush	70
Screws Brass & Steel Wood.....	54
Screws Clock Brass & Steel	54,55
Screws – Seat Board Assort.	18
Screws – Machine	54,55
Screws – Wood	54
Screwdrivers	51
Screwdrivers – Blades	51
Screwdrivers – Set	51
Screwdriver – Sharpener	51
Screwdriver – Quick Wedge	51
Scribe (Carbide Tip)	51
Seat Board Hooks	18
Shaping Stone	72
Shellac	57
Simichrome Polish	71
Solder- Stay-Bright	73
Solder- Tix	73
Split Stake	75, 76
Springs – Click	12,11
Springs – Click Assortment	11
Spring Wire – Brass	66
Spring Wire – Steel	66
Stabilizer (Wall)	18
Staking Set	48,75
Storage Boxes	47
Suspension Bridge	5
Suspension Springs	5,6,7
Suspension Springs Bulle.....	5
Suspension Spring Repair Kit	7
Suspension Spring on Rod	5
Suspension Steel	7
Suspension Spring 400 day	20,21
Scribe (Carbide Tip)	51

S

Suspension Spring Urgos	6
Super Glue	73

T

Tall Case Click	12
Tap & Die Set	36,76
Taper Pins Brass & steel.....	54
Taper Pin Brass & Steel Assort.	54
Taper Reamer	63
Taper Spindle	70
Tension Spring Assort.	11
Test Stand	31
Tie Down – Pendulums	5
Tools	63,72,75
Transfers	18
Tweezers	69
Tweezer - Sets	37

V

Verges Adjusting Tool	8
Verges	7
Verge Between Plates.....	8
Verges Guage	8
Verge Pin Plates	7
Verge Saddle	5
Verge Ware Plates	5
Verge Wire Retainer	8

W

Waller Carbide Graver	72
Watch Case Joint Pins	69
Watch Case Knives	69
Watch Case Openers	69
Watch display domes	12
Watch Oil	56,57
Wall Stabilizer	18
Weight	38
Weight Shell Fillers	38
Weight Shell	38
Weight Cuckoo	32
Weight Hooks	37
Winding Arbor Bushing	37,46,48
Winding Arbor Dummey	27
Wire Binding	66
Wire Brass Spring	66
Wire Pivot	66
Wire Rivet	66
Wire Steel Spring	66
Wobble Wedges	66